

REX-USB61

USB-SPI/I2C Protocol Emulator

User's Manual

2013.10

Rev. 1.0



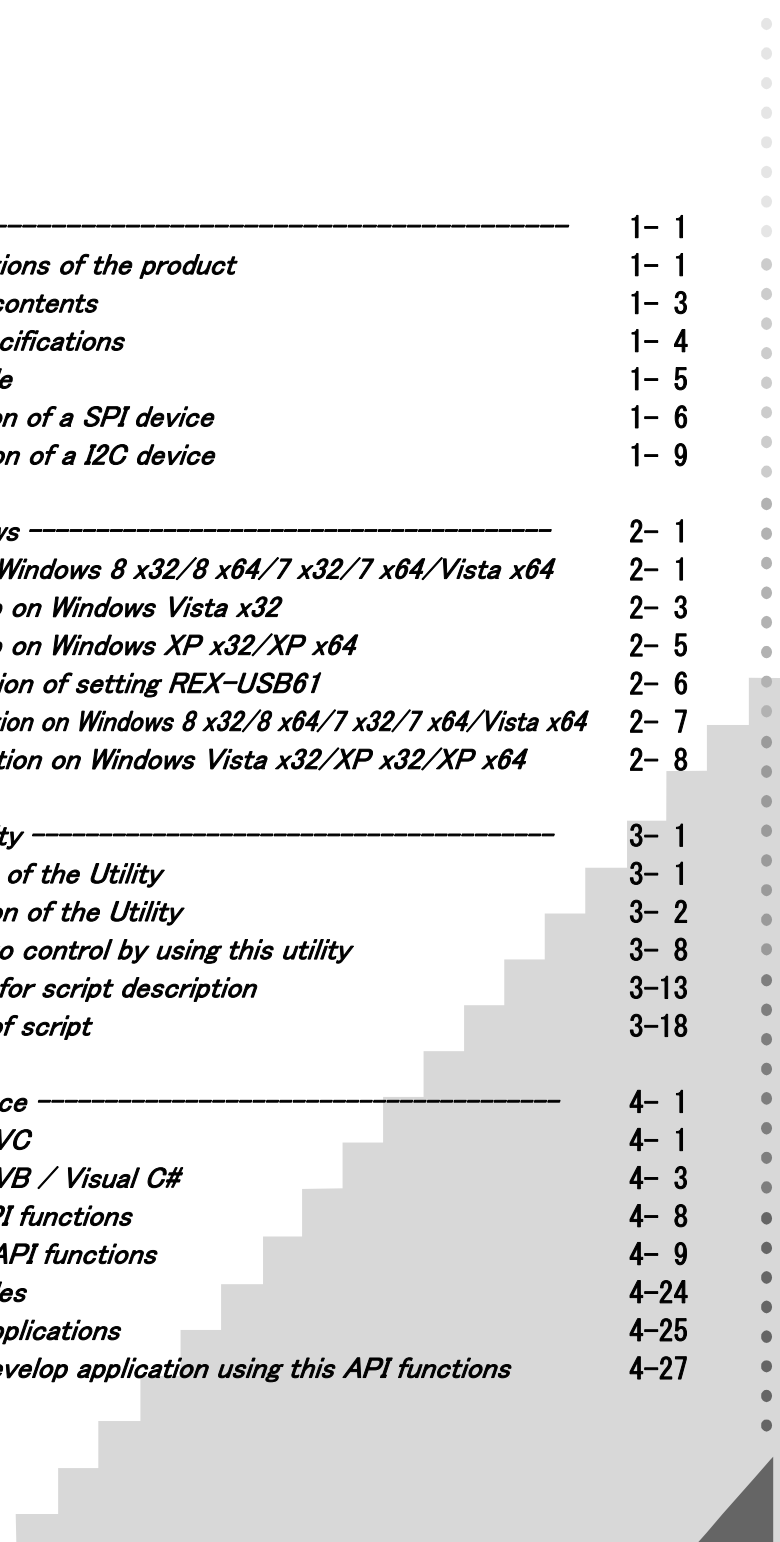
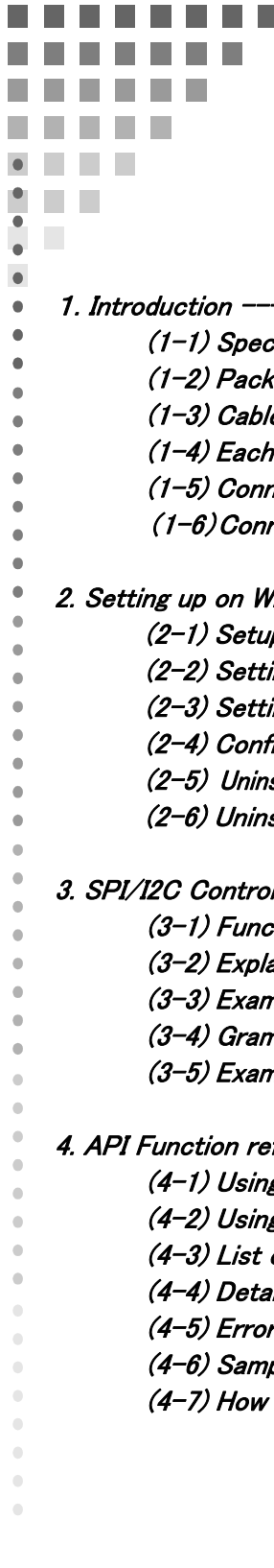

1. Introduction -----	1- 1
(1-1) Specifications of the product	1- 1
(1-2) Package contents	1- 3
(1-3) Cable specifications	1- 4
(1-4) Each mode	1- 5
(1-5) Connection of a SPI device	1- 6
(1-6) Connection of a I2C device	1- 9
2. Setting up on Windows -----	2- 1
(2-1) Setup on Windows 8 x32/8 x64/7 x32/7 x64/Vista x64	2- 1
(2-2) Setting up on Windows Vista x32	2- 3
(2-3) Setting up on Windows XP x32/XP x64	2- 5
(2-4) Confirmation of setting REX-USB61	2- 6
(2-5) Uninstallation on Windows 8 x32/8 x64/7 x32/7 x64/Vista x64	2- 7
(2-6) Uninstallation on Windows Vista x32/XP x32/XP x64	2- 8
3. SPI/I2C Control Utility -----	3- 1
(3-1) Functions of the Utility	3- 1
(3-2) Explanation of the Utility	3- 2
(3-3) Example to control by using this utility	3- 8
(3-4) Grammar for script description	3-13
(3-5) Example of script	3-18
4. API Function reference -----	4- 1
(4-1) Using on VC	4- 1
(4-2) Using on VB / Visual C#	4- 3
(4-3) List of API functions	4- 8
(4-4) Detail of API functions	4- 9
(4-5) Error Codes	4-24
(4-6) Sample applications	4-25
(4-7) How to develop application using this API functions	4-27

1. Introduction

(1-1) Specifications of the product

REX-USB61 enables you to easily control from a PC a variety of devices with SPI/I2C bus.

[This product comes with SPI/I2C control utility]

This bundled utility can control SPI/I2C, GPO(General Purpose Output) and save a setting file or log file.

For further information, please refer to Chapter 3.

[This product also comes with API library and sample program]

Making an application software with the API library enables you to control the following:

- Can provide a power supply of 3.3V or 5.0V([N.B.] current is under 100mA) from this product to an external device.
- Can provide from 1.8V to 5.0V an input/output level of SPI/I2C/slave port/parallel out port as long as a power supply terminal of this product is provided by a external voltage.
- Can change SPI/I2C, master/slave(SPI is a master only)
- Can specify a frequency of SPI/I2C bus.
- Can output a digital of 4bit at I2C mode.

And this product comes with program source codes by which you can use API library.

(For further information on functions, please refer to (4-4) at Chapter 4.

Further information on applications, please refer to (4-6) at Chapter 4.)

[The latest firmware is available through our website]

You can update firmware in order to add or change specifications on this products. The latest firmware and update program is available through our website.

Hardware specifications

Item	Specifications
Host Interface	USB2.0 Full Speed Device
Connector	USB mini B connector
Voltage	5V (via USB bus power)
Consumption Current	100mA
Device Interface	SPI Master Max. frequency 12MHz I2C Master/Slave Frequency 47KHz~1MHz
Input/Output level	[Output] 3.3V/5V [Input] 1.8V - 5.0V is enabled with external P/S
Dimension	57(W) x 75(D) x 18(H) mm
Weight	Approx.60g (except cable)
Operating Environment	Temperature:5~55°C Humidity:20~80% (non condensing)

Support Operating System

Windows 8/7/Vista/XP * Works both 32bit OS and 64bit OS

Software

Item	File	Description
Setting file for installation	USB61.inf	Setting file for REX-USB61 (Windows Vista x32/XP x32/XP x64)
Installer	USB61_Setup.exe	Installer for Windows 8 x32/8 x64/7 x32/7 x64/Vista x64
Utility	Usb61Uty.exe	Utility to control SPI/I2C
Script file	I2C_script.txt SPI_script.txt	Script file for I2C bus control Script file for SPI bus control
Sample program (VC6.0/VB6.0/VB2005/C#)	EEPROMRWUty I2cSlaveSample	Sample program to send/receive SPI/I2C Sample program for I2C slave
Library	usb61api.dll usb61def.h usb61api.bas usb61api.vb	Library to control SPI/I2C devices Header file for Visual C Module for Visual Basic Code file for Visual Basic
ActiveX control	usb61api.ocx	ActiveX control for REX-USB61
Uninstall utility	USB61_uninst.exe	Utility to delete INF file (Windows XP x32/XP x64)

* REX-USB61 can only use 1 device.

On the other hand, REX-USB61M can use multiple devices.

(1-2) Package contents

REX-USB61 package includes:

- ☑ REX-USB61
- ☑ CD-ROM
- ☑ USB A – mini B cable
- ☑ SPI/I2C cable
- ☑ Warranty Card

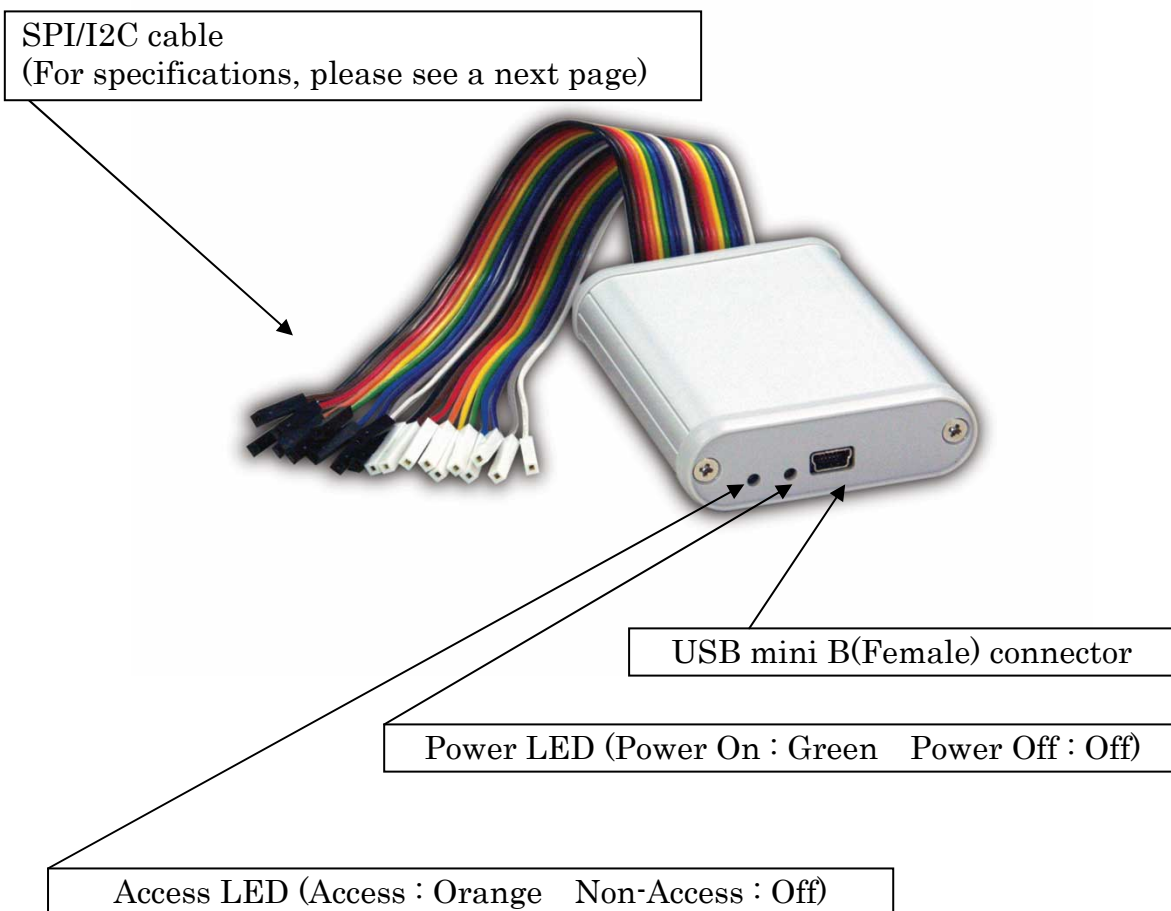

(1-3) Cable Specifications

The below explains the specifications of the cable bundled with REX-USB61.

Pin number	Housing color	Cable color	Signal	Usage
1	Black	Brown	Power	Input/Output of power supply for a target device (Output 5V or 3.3V @100mA) (Input 1.8V - 5V)
2	Black	Red	Power	Input/Output of power supply for a target device (Output 5V or 3.3V @100mA) (Input 1.8V - 5V)
3	Black	Orange	1MHz - SCL	Clock for I2C (401KHz - 1MHz bus voltage 5V only) (Pull-up resistance 10kΩ)
4	Black	Yellow	1MHz - SDA	Data signal for I2C (401KHz - 1MHz bus voltage 5V only) (Pull-up resistance 10kΩ)
5	Black	Green	SCL	Clock for I2C (47KHz-400KHz 1.8-5V) (Pull-up resistance 10kΩ)
6	Black	Blue	SDA	Data signal for I2C (47KHz-400KHz 1.8-5V) (Pull-up resistance 10kΩ)
7	Black	Purple	SCK	Clock signal for SPI (12MHz 1.8 - 5V)
8	Black	Gray	SDO	Data out signal SPI (12MHz 1.8 - 5V)
9	Black	White	SDI	Data in signal SPI (12MHz 1.8 - 5V)
10	Black	Black	Reserve	N/A(Don't use)
<p>* Don't use I2C 401KHz-1MHz(Pin#3,4) and SPI(Pin#7,8,9) at the same time.</p>				

Pin number	Housing color	Cable color	Signal	Usage
11	White(Gray)	Gray	GND	Ground
12	White(Gray)	Red	GND	Ground
13	White(Gray)	Orange	DO0	SS0 for SPI/PORT0 for I2C (1.8 - 5V)
14	White(Gray)	Yellow	DO1	SS1 for SPI/PORT1 for I2C (1.8 - 5V)
15	White(Gray)	Green	DO2	SS2 for SPI/PORT2 for I2C (1.8 - 5V)
16	White(Gray)	Blue	DO3	SS3 for SPI/PORT3 for I2C (1.8 - 5V)
17	White(Gray)	Purple	GND	Ground
18	White(Gray)	Gray	GND	Ground
19	White(Gray)	White	N.C.	N.C.
20	White(Gray)	Black	N.C.	N.C.

(1-4) Each mode

The below explains master/slave mode on SPI /I2C bus.

Bus	Operation	
SPI Bus	Master mode	This mode can select a slave, send data, display data received from the slave.
I2C Bus	Master mode	This mode can send data to a particular address, display data received from the slave.
	Slave mode	This mode can display data received to self-address, send data to master.

You can select master mode or slave mode of REX-USB61 by the bundled utility software or API library.

(1-5) Connection of a SPI device

The below explains how to connect an EEPROM with SPI interface.

- Regarding power supply of REX-USB61

In order to provide power supply to a level converter IC on the REX-USB61, **it is required to connect the power pin of the REX-USB61 to a power supply of a target device**, even if the target device doesn't have power supply.

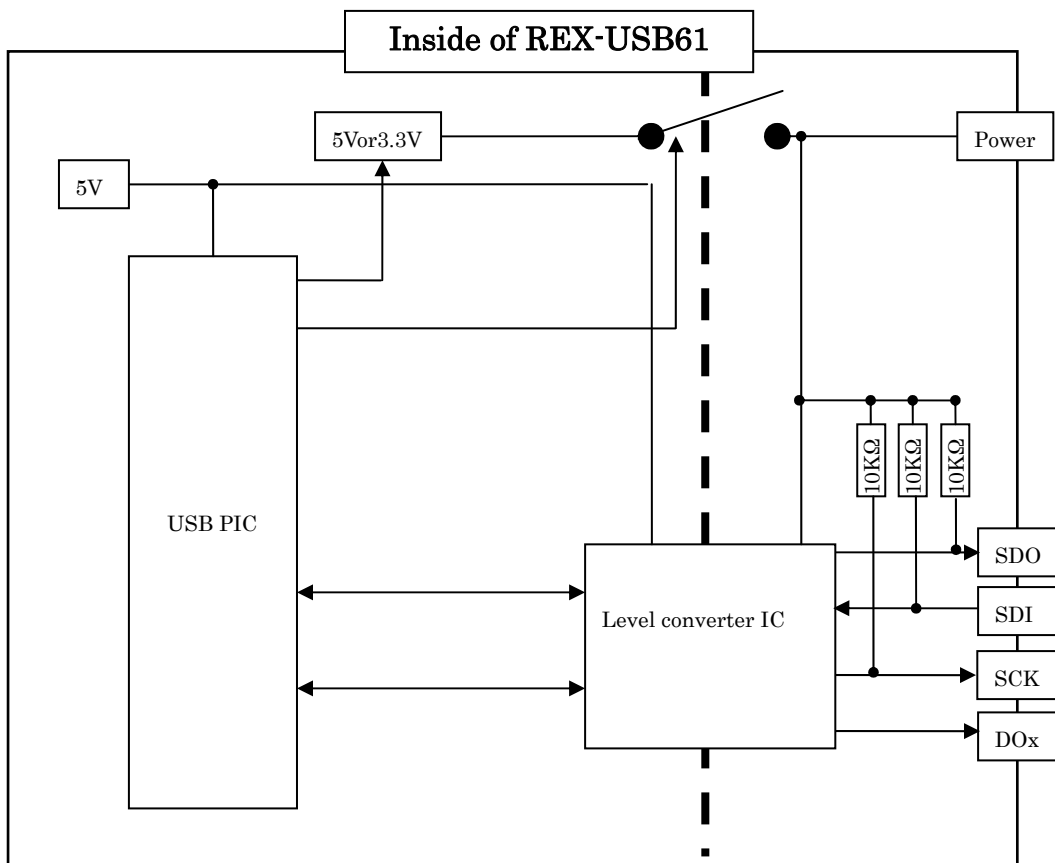

[Caution]

When connecting/disconnecting a device, never provide power to REX-USB61 nor the device.

(If you provide power to REX-USB61 or the device and connect or disconnect the device, REX-USB61 will be broken.)

SPI Connection(If a target device has power supply)

If a target device has power supply, please disable power supply by utility software or application which uses an API library.

(The library is called `usb61_power_control()`. Refer to (4-4) at Chapter 4.)

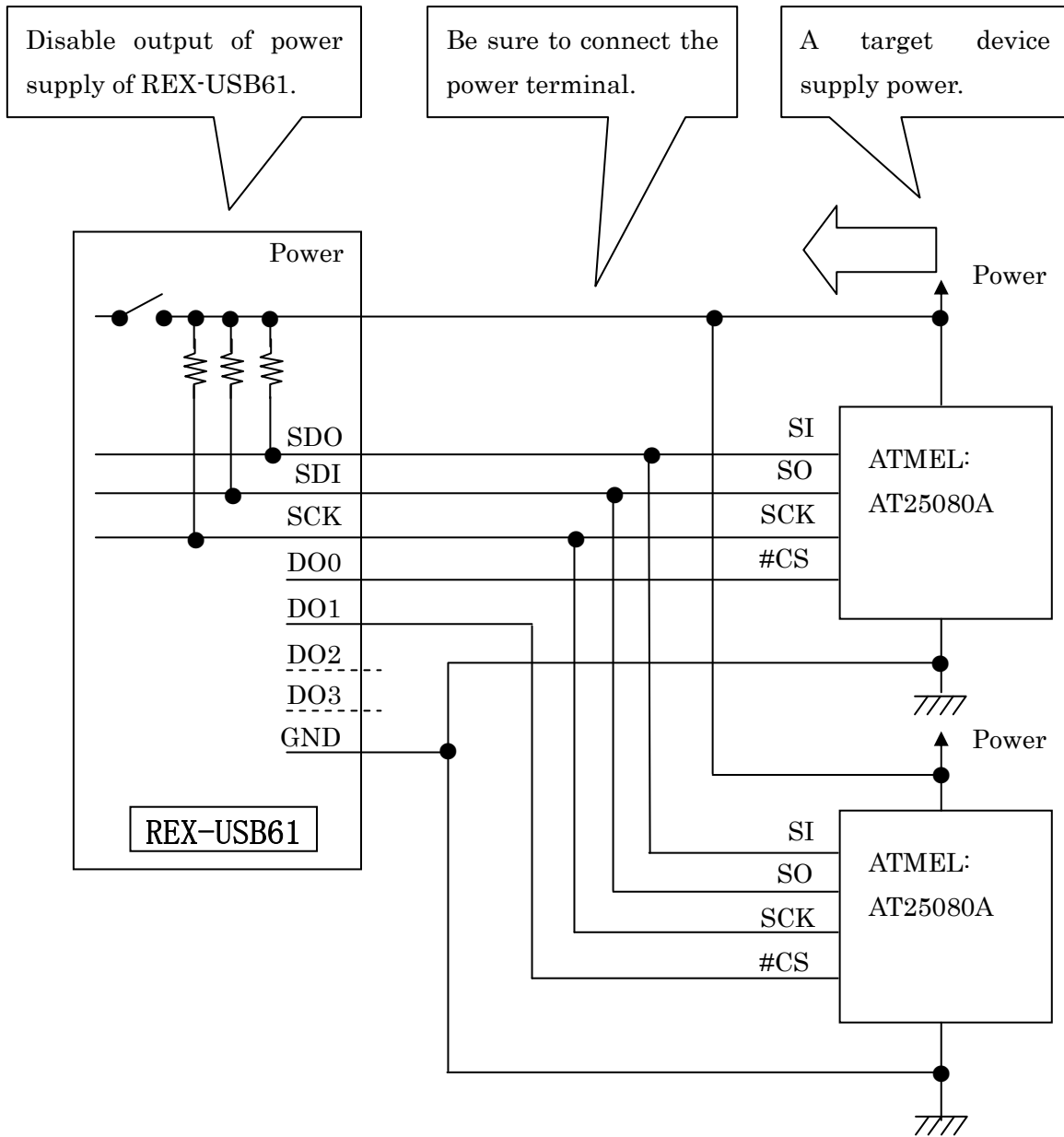

SPI Connection(If a target device doesn't have power supply)

If REX-USB61 supply power(3.3V/5.0V) to a target device, please use utility software or application which uses an API library.

(The library is called `usb61_power_control()`. Refer to (4-4) at Chapter 4.)

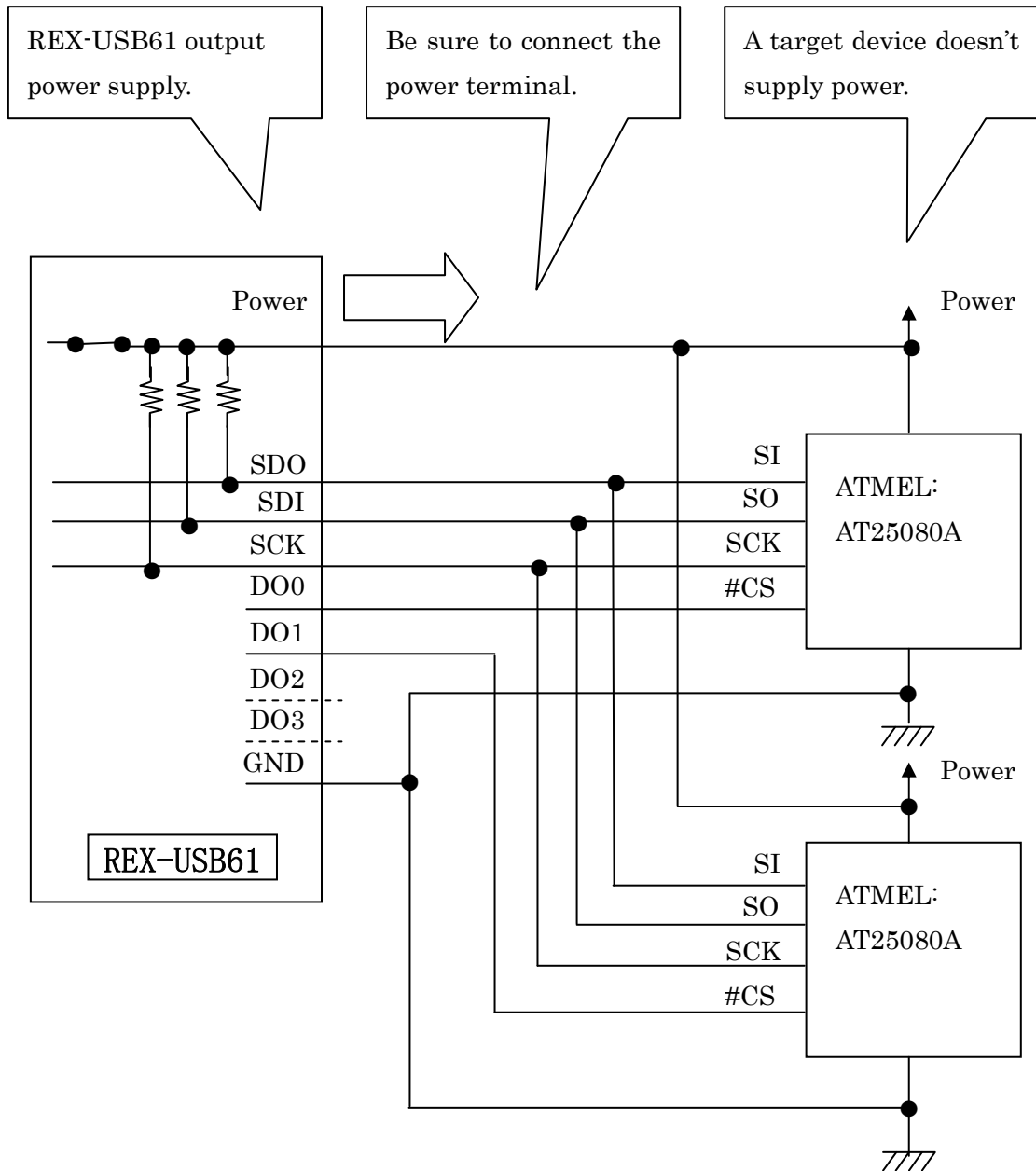

(1-6) Connection of a I2C device

The below explains how to connect an EEPROM with I2C interface.

- Regarding power supply of REX-USB61

In order to provide power supply to a level converter IC on the REX-USB61, **it is required to connect the power pin of the REX-USB61 to a power supply of a target device**, even if the target device doesn't have power supply.

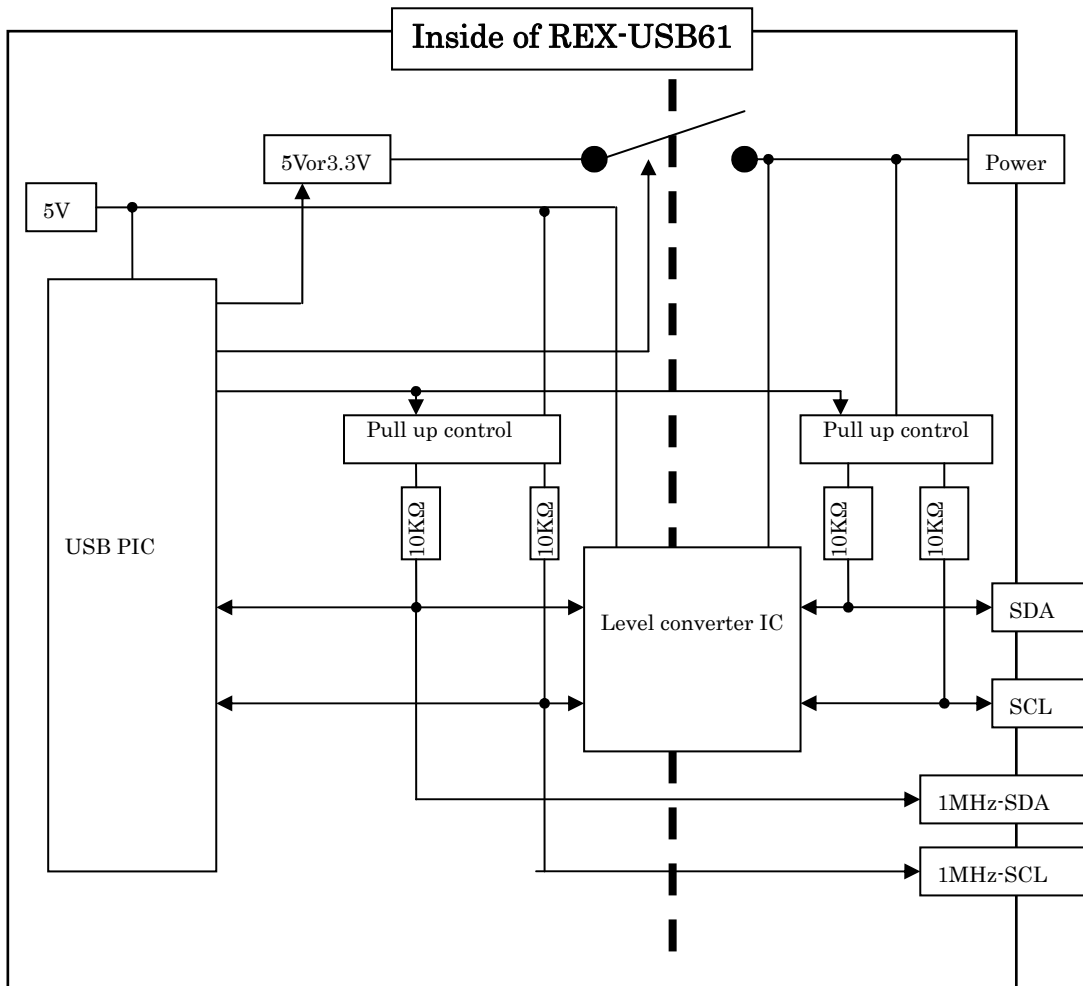

[Caution]

When connecting/disconnecting a device, never provide power to REX-USB61 nor the device.

(If you provide power to REX-USB61 or the device and connect or disconnect the device, REX-USB61 will be broken.)

I2C connection(If a target device has power supply)

If a target device has power supply, please disable power supply by utility software or application which uses an API library.

(The library is called `usb61_power_control()`. Refer to (4-4) at Chapter 4.)

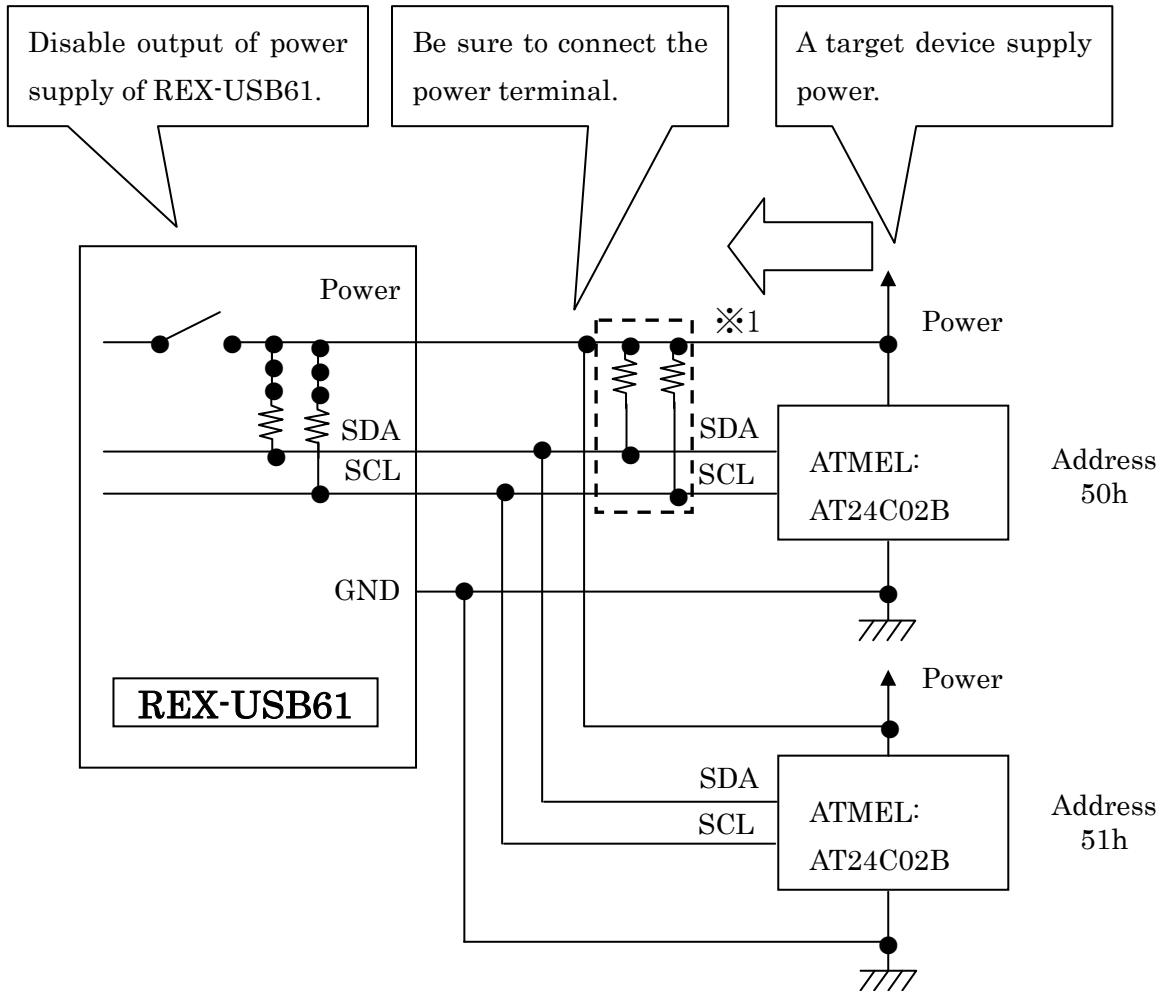

*1 The pull-up resistance on REX-USB61 is 10KΩ.

If necessary, add pull-up resistance.

I2C connection(If a target device doesn't power supply)

If REX-USB61 supply power(3.3V/5.0V) to a target device, please use utility software or application which uses an API library.

(The library is called `usb61_power_control()`. Refer to (4-4) at Chapter 4.)

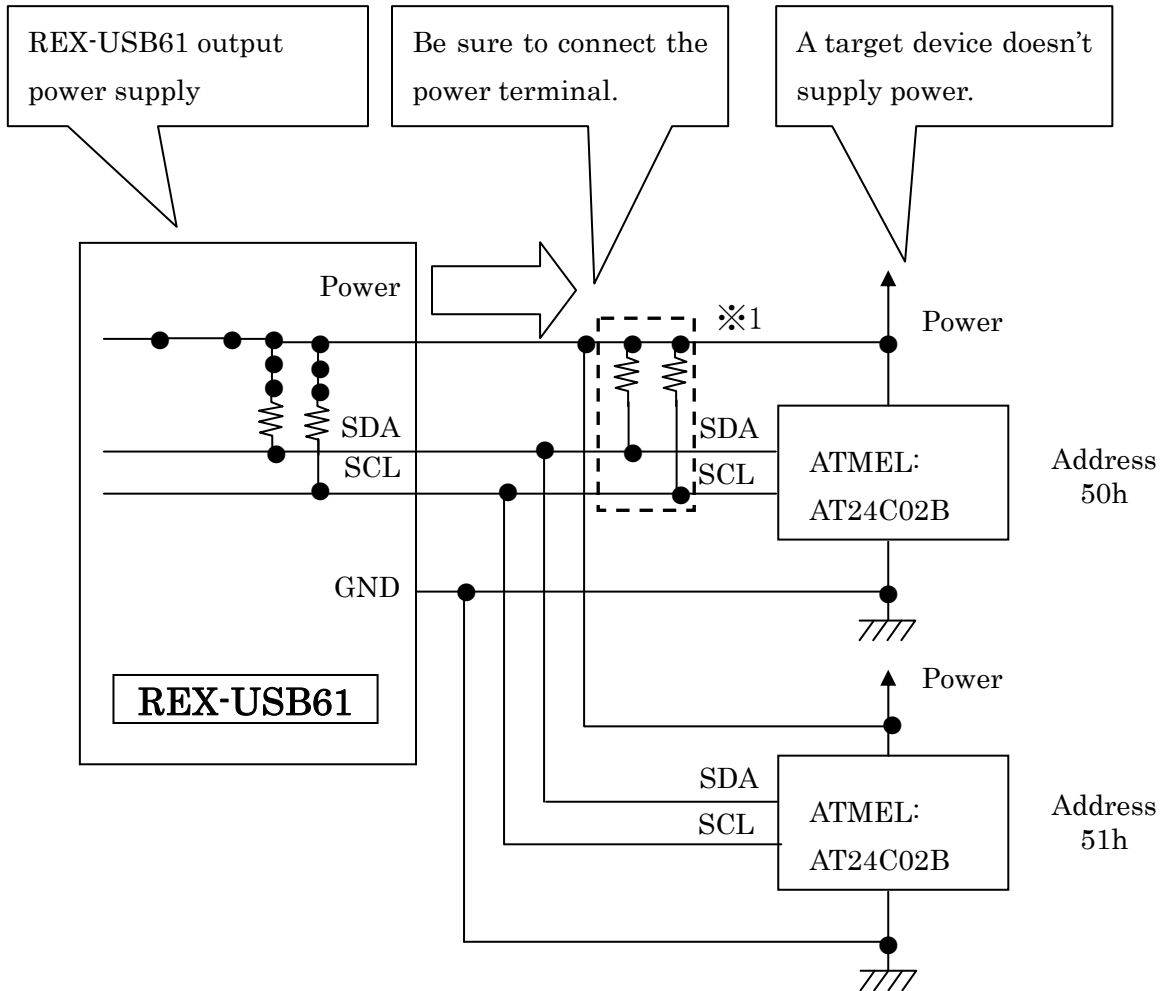

*1 The pull-up resistance on REX-USB61 is 10KΩ.

If necessary, add pull-up resistance.

I2C connection [1MHz-SCL / 1MHz-SDA] (If a target device has power supply)

If a target device has power supply, please disable power supply by utility software or application which uses an API library.

(The library is called `usb61_power_control()`. Refer to (4-4) at Chapter 4.)

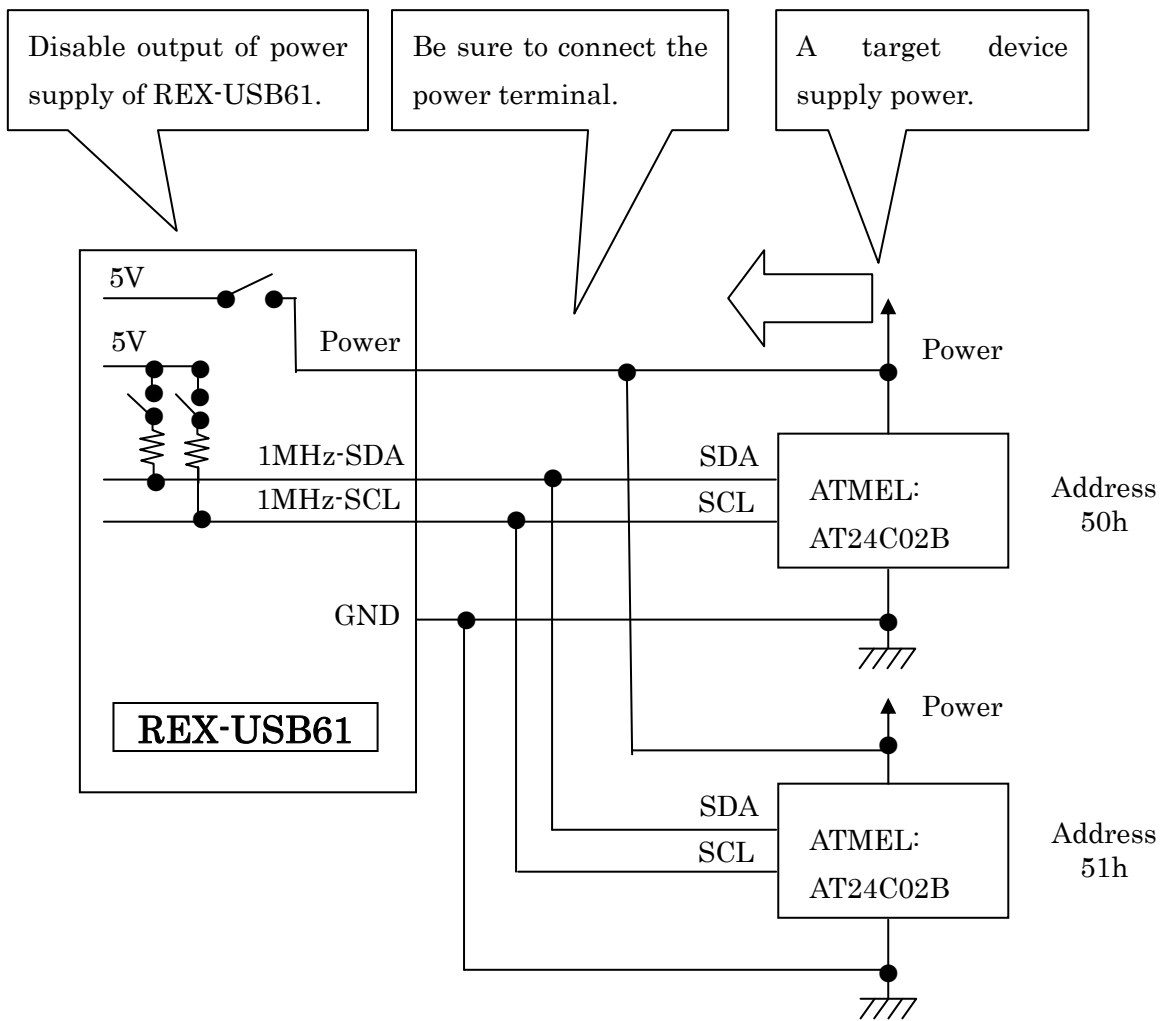

* Only after providing power to all devices, set on pull-up resistance.

* If a target device provide power, don't attach pull-up resistance on I2C bus.

I2C connection [1MHz-SCL / 1MHz-SDA]

(If a target device doesn't have power supply)

If REX-USB61 supply power(5.0V) to a target device, please use utility software or application which uses an API library.

(The library is called `usb61_power_control()`. Refer to (4-4) at Chapter 4.)

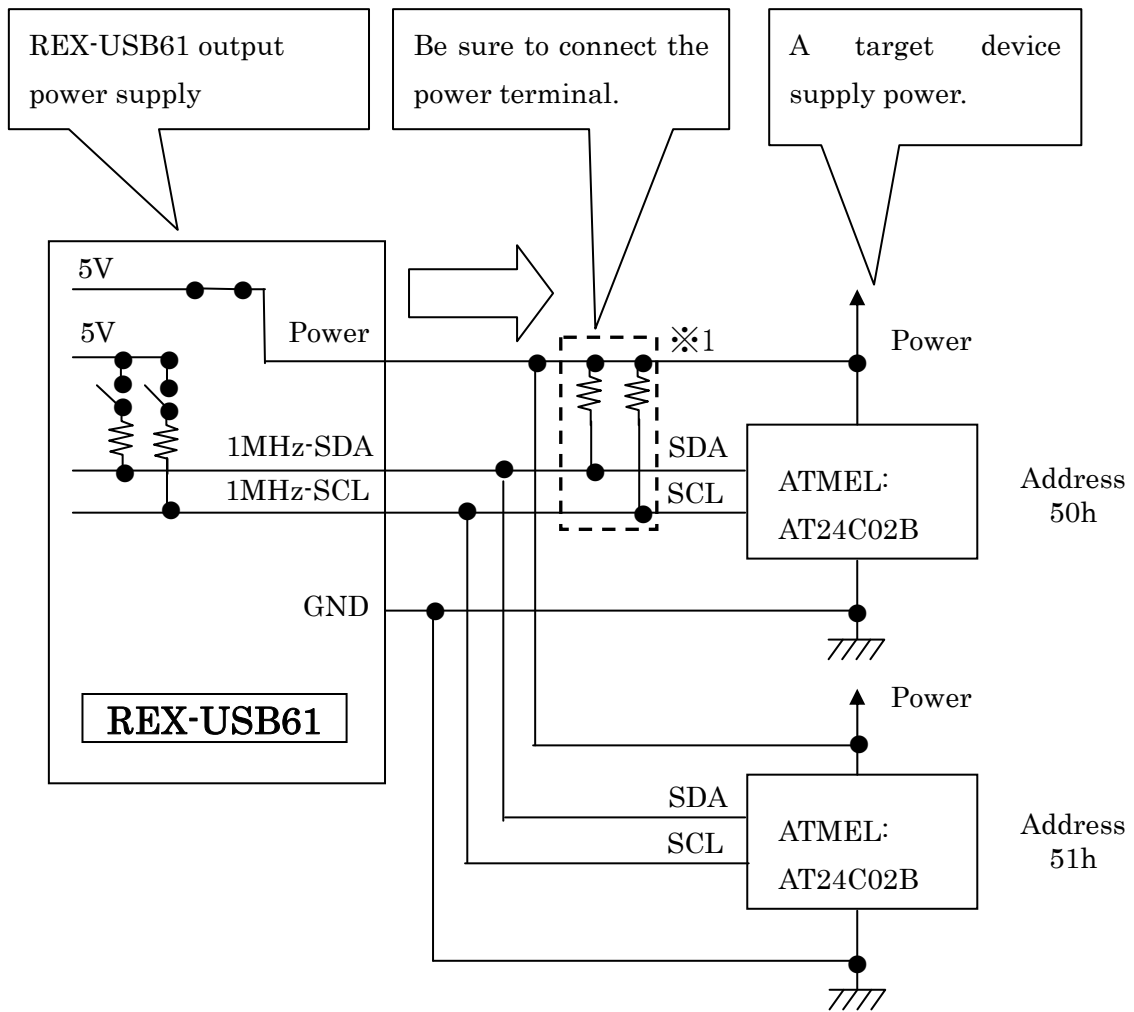

*** Only after providing power to all devices, set on pull-up resistance.**

*1 The pull-up resistance on REX-USB61 is 10KΩ.

If necessary, add pull-up resistance.

2. Setting up on Windows

(2-1) Set up on Windows 8 x32/8 x64/7 x32/7 x64/Vista x64

Turn on the PC and proceed to the below installation before connecting REX-USB61 to the USB port.

Start

Win8_7_VistaX64\USB61_Setup.exe at the bundled CD-ROM.

If user account window appear, click [Yes].

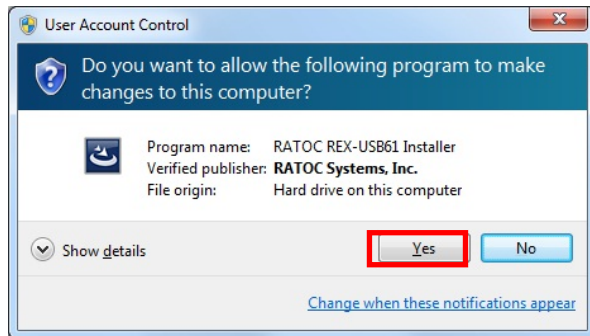

RATOC REX-USB61 Installer will start. Click [Next].

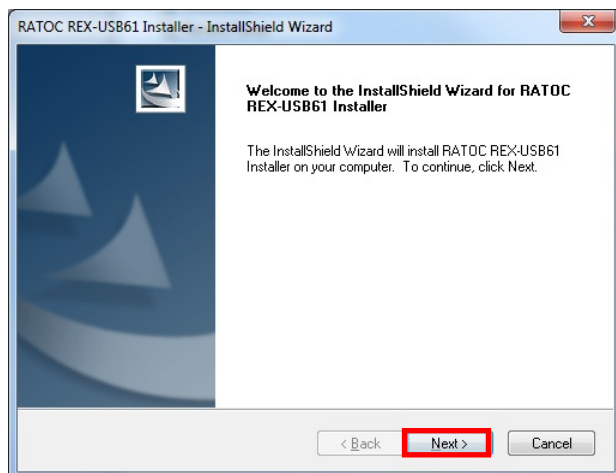

Click [Install].

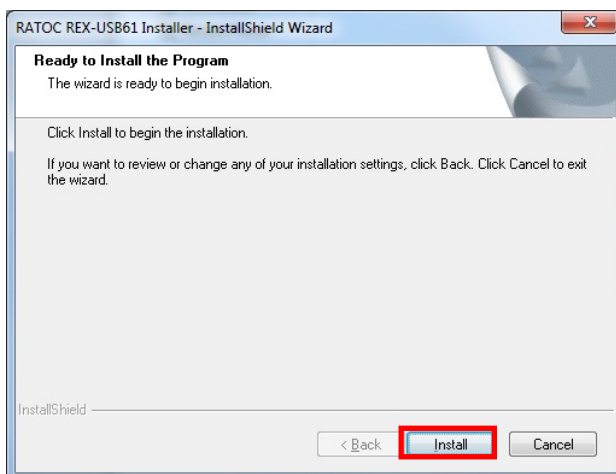

Click [Install] on the Windows Security window.

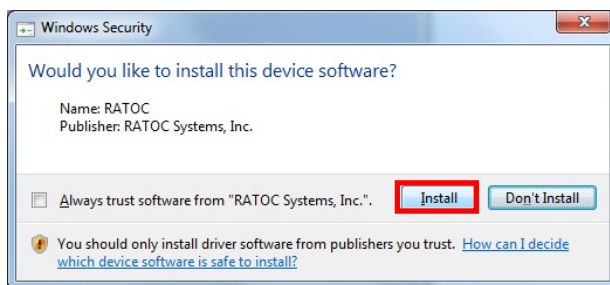

The set up has finished.

If REX-USB61 is connected to the PC, the installation will automatically finish.

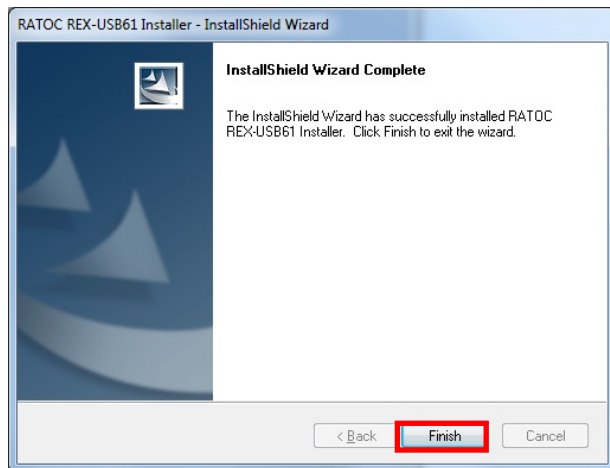

Proceed to (2-4) Confirmation of setting REX- USB61 to confirm the installation has finished properly.

(2-2) Setting up on Windows Vista x32

Turn on the PC and connect REX-USB61 to the USB port.

The below hardware wizard will start up. Proceed to the below instruction.

Select [Locate and install driver software (recommended)].

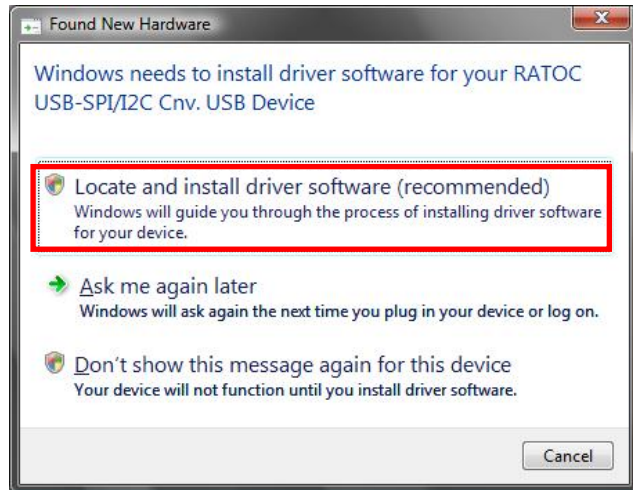

If user account window appear, click [Yes].

Click [Don't search online], as shown right.

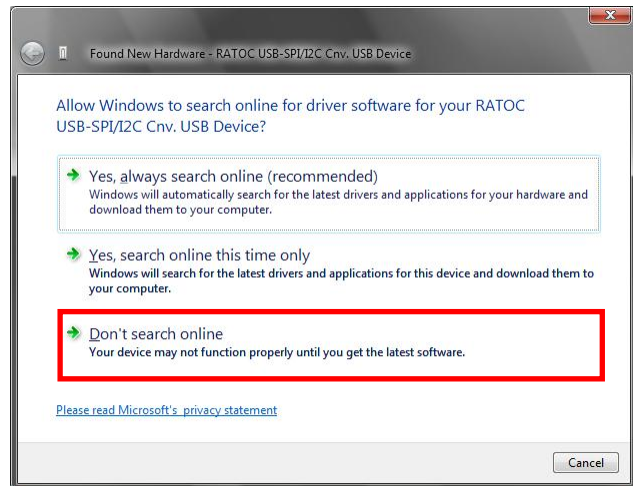

Insert the bundled CD-ROM and click [Next].



Select [Install this driver software anyway].

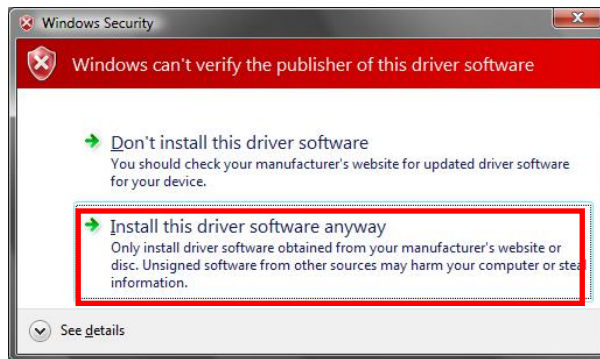

The installation of REX-USB61 has finished.

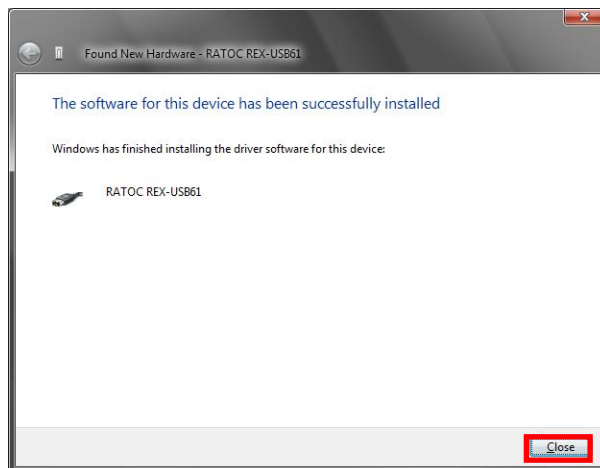

Proceed to (2-4) Confirmation of setting REX- USB61 to confirm the installation has finished properly.

(2-3) Setting up on Windows XP x32/XP x64

Turn on the PC and connect REX-USB61 to the USB port.

The below hardware wizard will start up. Proceed to the below instruction.

Select [No, not this time] and click [Next].



Insert the bundled CD-ROM and select [Install the software automatically(Recommended)] and click [Next].

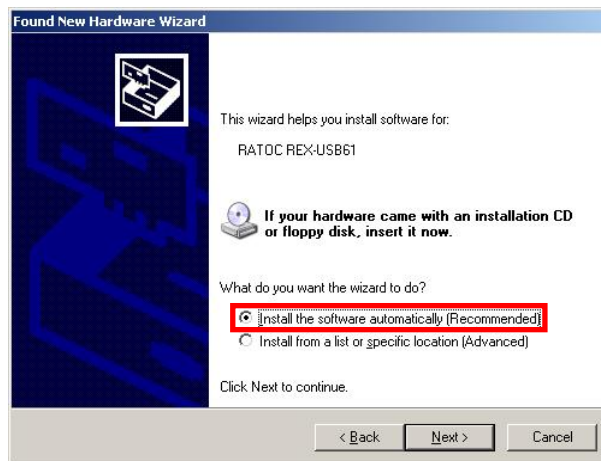

The installation of REX-USB61 has finished.



Proceed to (2-4) Confirmation of setting REX- USB61 to confirm the installation has finished properly.

(2-4) Confirmation of setting REX- USB61

Open [Device Manager].

(※ On Windows XP x32/XP x64, open [Control Panel] and [System].

And select the [Hardware] tab and click the [Device manager] button.)

Confirm there is a string of [RATOC REX-USB61] properly under the [SPI/I2C Converter Device].

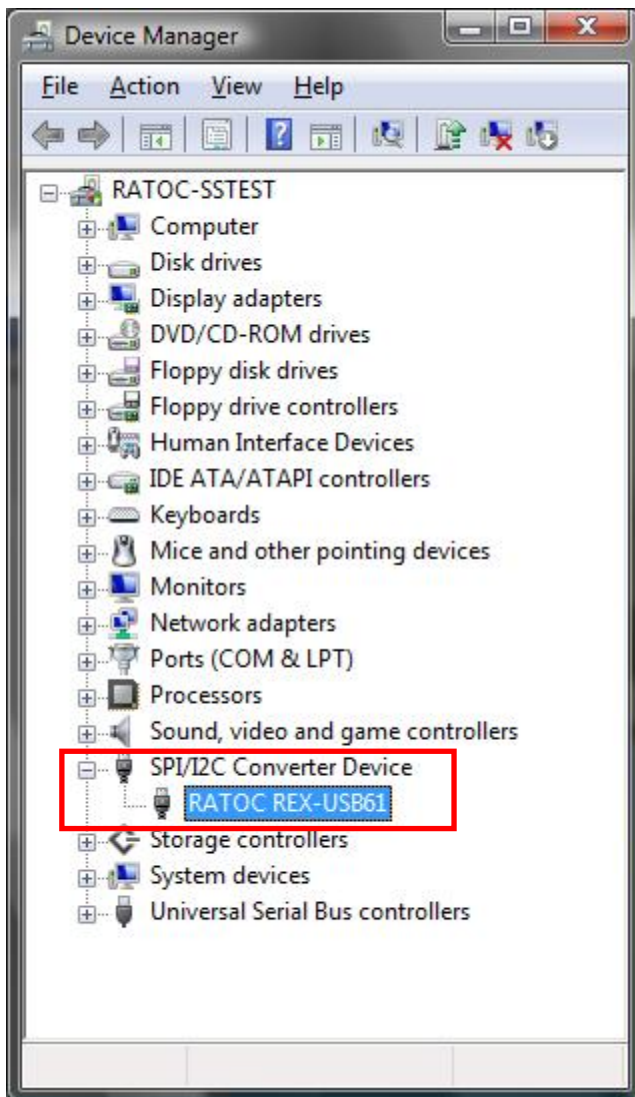

(2-5) Uninstallation on Windows 8 x32/8 x64/7 x32/7 x64/Vista x64
Start [Programs and Functions].

Select [RATOC REX-USB61
Installer] and click [Uninstall].

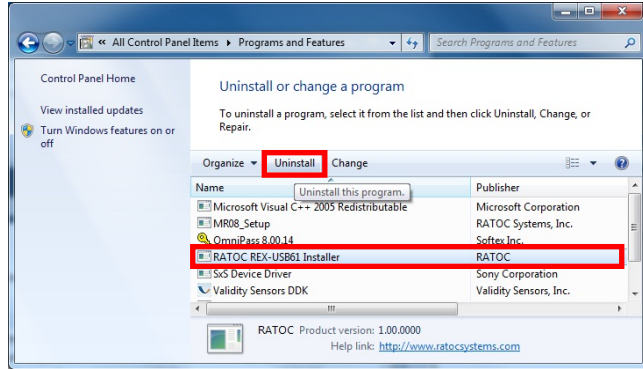

Click [Yes].

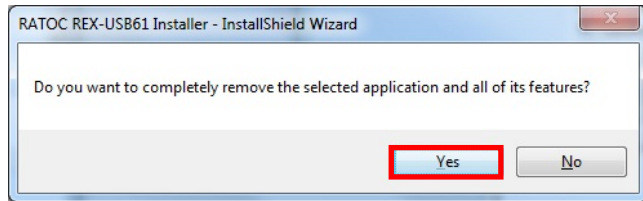

The uninstallation of
REX-USB61 has finished.

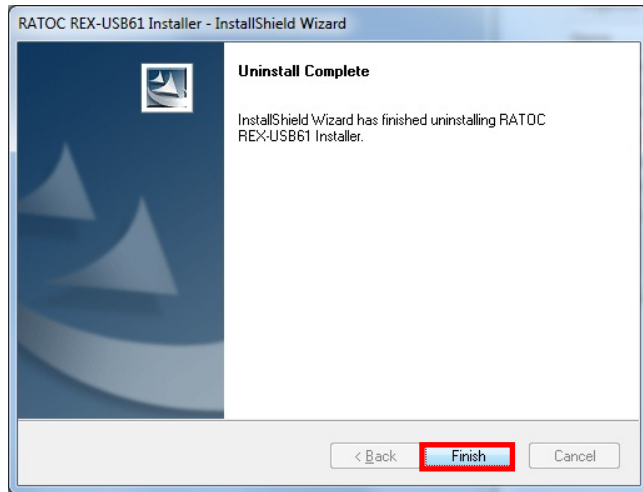

(2-6) Uninstallation on Windows Vista x32/XP x32/XP x64

To uninstall REX-USB61, you have to delete the driver and INF file.
(On Windows Vista, you have to delete the driver only.)

• Delete the driver

Open [Device Manager].
(※ On Windows XPx32/XPx64, open [Control Panel] and [System].
And select the [Hardware] tab and click the [Device manager] button.)

Right-click the [RATOC REX-USB61] and select [Uninstall].

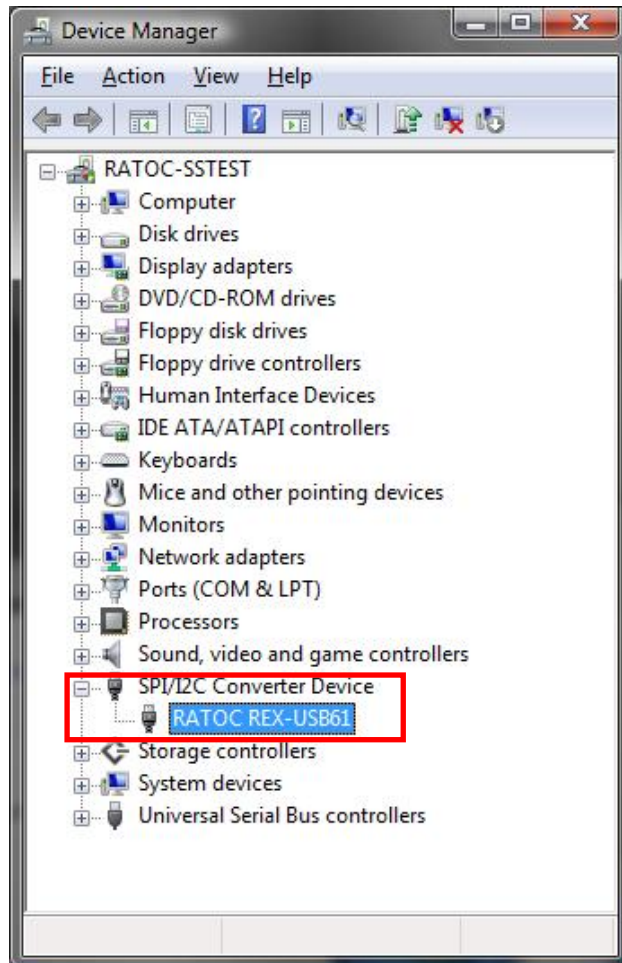

On Windows Vista x32, put the check mark, as shown right and click [OK].



- **Delete INF file**

(Windows XPx32/XPx64)

Start [USB61_uninst.exe] at the bundled CD-ROM.

([CD-ROM]:¥USB61_uninst.exe)

When the dialog shown right appear, click [OK].

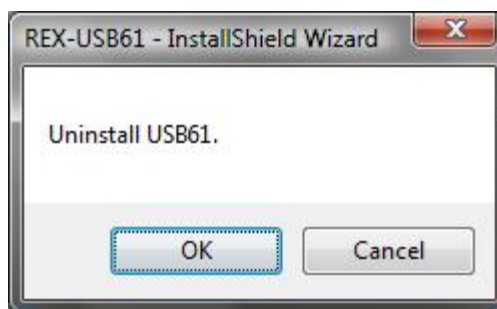

When the dialog shown right appear, click [OK].

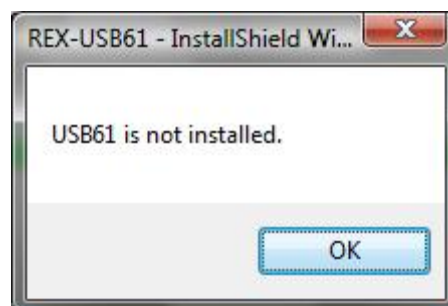

The uninstallation of REX-USB61 has finished.

3. SPI/I2C Control Utility

(3-1) Functions of the utility

The bundled Usb61Uty.exe can control a target device with SPI or I2C interface and has the following functions:

- Switch operation modes for SPI and I2C
- Control SPI device(Master operation)
- Control I2C device(Master/Slave operation)
- Control PORT pin
- Read/Write setting values
- Save setting files(BIN file format)
- Load setting files
- Save log files(CSV file format)

Table 3-1 Utility Functions

		Functions
Common items	Supply power to a target device	
	Set an time interval between data	
	Save transfer log files	
	Switch operation modes for SPI and I2C	
SPI bus	Master	Set clock polarity
		Set clock phase
		Set precedent bit
		Set frequency
		Set slave select pin(Max.4)
		Create transfer data
		Edit transfer data
		Send step-by-step transfer data
		Send batch transfer data
		Repeatedly send transfer data
		Save transfer data file
		Read transfer data saved in a file
		I2C bus
Create transfer data		
Edit transfer data		
Send step-by-step transfer data		
Send batch transfer data		
Repeatedly send transfer data		
Save transfer data file		
Read transfer data saved in a file		
Issue bus reset		
Output PORT pin		
Slave	Set frequency	
	Set response data to a master	
	Set slave address	

(3-2) Explanation of the utility

The below explains screens of the utility and each function.

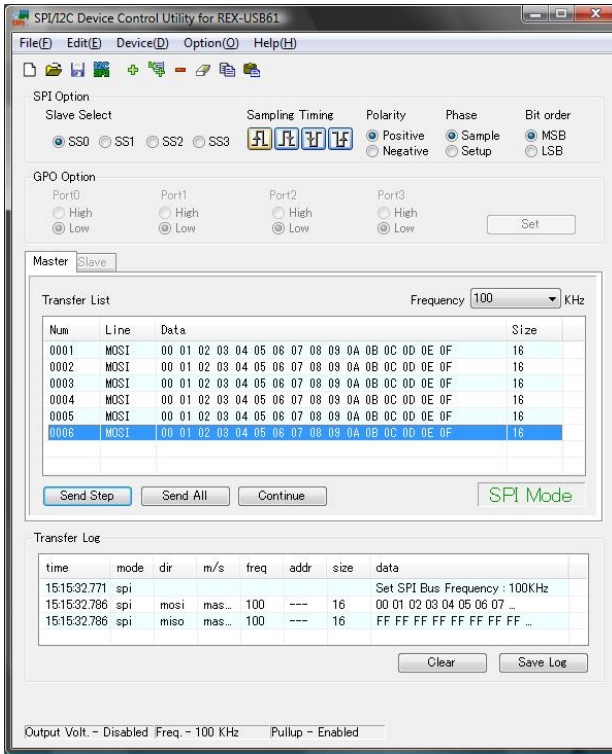

Fig 3-1. SPI master mode

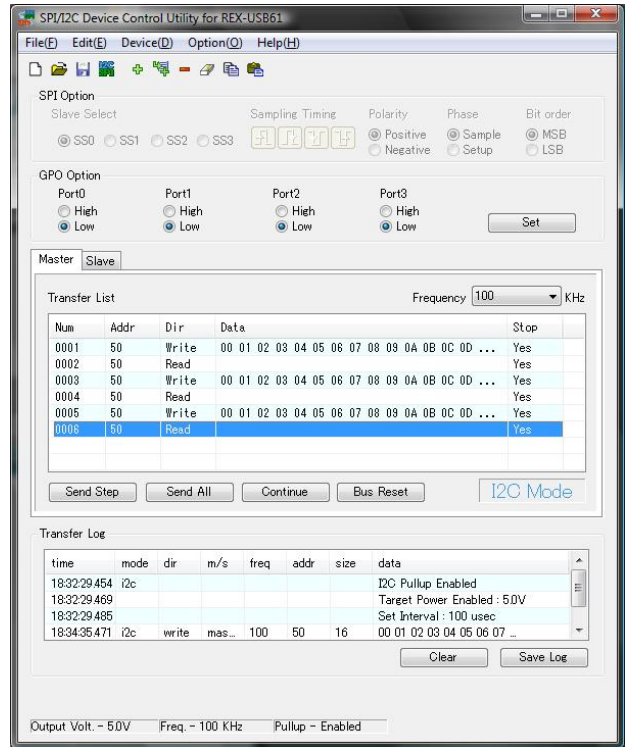

Fig 3-2. I2C master mode

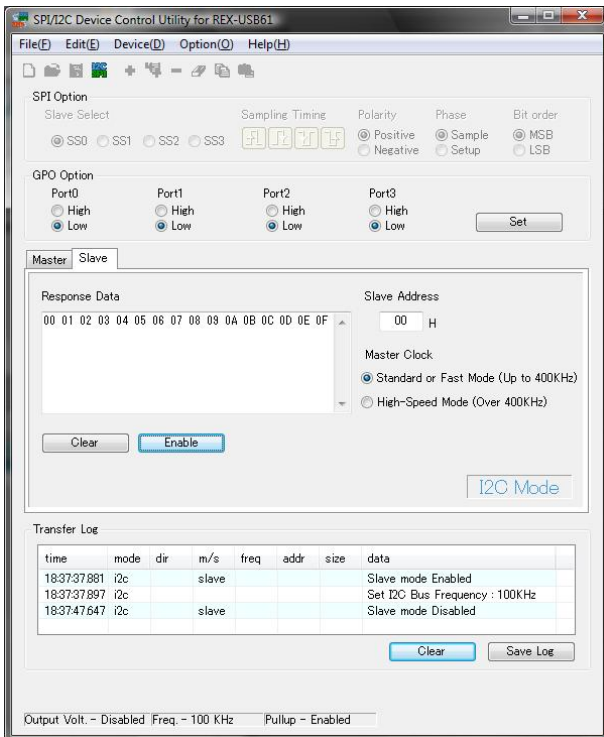

Fig 3-3. I2C slave mode

Menu bar**File(F)**

- Create : Create a new setting file
- Open : Open a setting file
- Overwrite : Overwrite a current setting
- Save a file : Save a current setting as a new name
- End : End application

* All functions except [End] can work on master mode only.

Edit(E)

- Add : Add a new transfer data to the end of transfer list
- Insert : Insert a new transfer data into the transfer data number selected now
- Delete : Delete a selected transfer list
- Erase : Erase a content of the selected transfer list
- Copy : Copy a content of the selected transfer list
- Paste : Paste a copied content of the transfer list onto a selected number

* All functions can work on master only.

Devices(D)

- Switch SPI/I2C : Switch modes between the SPI and I2C bus





Options(O)





- Setting : Switch pull-up conditions of the I2C bus signal
Set whether to supply power to devices
Set a voltage of power supply(3.3V, 5.0V)
Set a time interval for each 1 byte
- View list/Switch scripts : View list and switch scripts

Help(H)

- Version information : Display version of this application

Tool bar

-  Same as [Create] of [Files] at the menu bar
-  Same as [Open] of [Files] at the menu bar
-  Same as [Overwrite] of [Files] at the menu bar
-  Switch modes between SPI and I2C mode
-  Same as [Add] of [Edit] at the menu bar

-  Same as [Insert] of [Edit] at the menu bar
-  Same as [Delete] of [Edit] at the menu bar
-  Same as [Erase] of [Edit] at the menu bar
-  Same as [Copy] of [Edit] at the menu bar
-  Same as [Paste] of [Edit] at the menu bar

Controls**SPI Option**

- SPI Option : Set SPI mode
 - Slave Select : Select slave select pin
 - Sampling Timing : Set when to sample by which part of a clock
 - Polarity : Select positive polarity or negative polarity
 - Phase : Select phase. Select sampling or setup.
 - Bit order : Select which bit is transmitted first, MSB or LSB.
- * Setting of Sampling Timing, Polarity, Phase operate with each other.

GPO Option

- Port0~3 : Set each PORT(Output only)
- High/Low : Set/Display a value at each port
- Set : Output to each Port

Master

- Transfer List : Display the content of setting transfer
 - ① Num : Number of transfer data
 - ② Addr : Device address
 - ③ Dir : Direction of transfer. Display Read or Write
 - ④ Line : Display data line name. Display MOSI or MISO
 - ⑤ Data : Display data content
 - ⑥ Stop : Display whether to stop condition is issued.
 - ⑦ Size : Data size
- Send : Transfer selected data
- Send All : Transfer all of setting items at the list view
- Continue : Repeatedly transfer setting items at the list view
- Bus Reset : Issue a bus reset of the I2C bus

Slave

- Slave Address : Set slave address
N.B.) Refer to Page.4-16 for how to appoint an address
- Response Data : Set data to be returned to a master
- Clear : Delete returned data
- Enable : Enable slave operation

Master/Slave common

- Sampling rate : Set/display a sampling rate(frequency).
 You can set a sampling rate(frequency) by 1KHz each.
 For SPI, a sampling rate(frequency) will be set at an approximate value which can be really set.
 (I2C:47KHz - 1MHz / SPI: Up to 12MHz)
 * For how to calculate an approximate value,
 please refer to a `usb61_spi_set_freq()` function at Chapter 4.

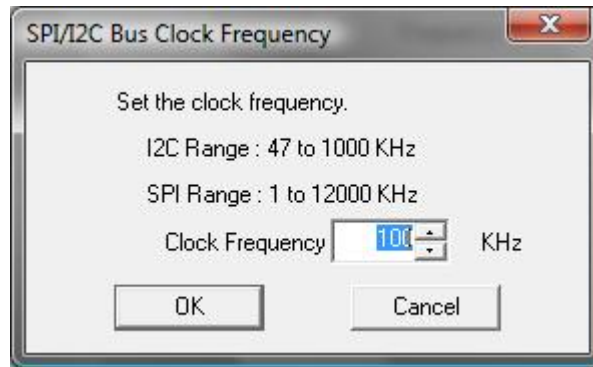

[Setting sample rate]

- Device Mode : Display a current operating mode (SPI Mode or I2C Mode)
- Output Volt : Display a current output at the lower left.
- Freq : Display a current sampling frequency at the lower left.
- Pull-up : Display a current I2C bus pull-up conditions.

Log

- Transfer Log : Display a log of the content of transfer
 - ① time : Display time when a log is added(hh:mm:ss:msec)
 - ② mode : Display transfer mode for SPI/I2C(SPI/I2C)
 - ③ dir : Display transfer direction(read/write, miso/mosi)
 - ④ m/s : Display master/slave mode(master/slave)
 - ⑤ freq : Display operating frequency(in KHz)
 - ⑥ addr : Display I2C slave address (in Hex number)
 - ⑦ size : Display a length of data transfer(in Decimal number)
 - ⑧ data : Display transfer data(Data after 8 bytes will be omitted)
- Clear : Delete the content of transfer log
- Save Log : Save a log file(in CSV file format)

Edit window for transfer data

If you double-click a row at the transfer list, the below edit window will be shown.

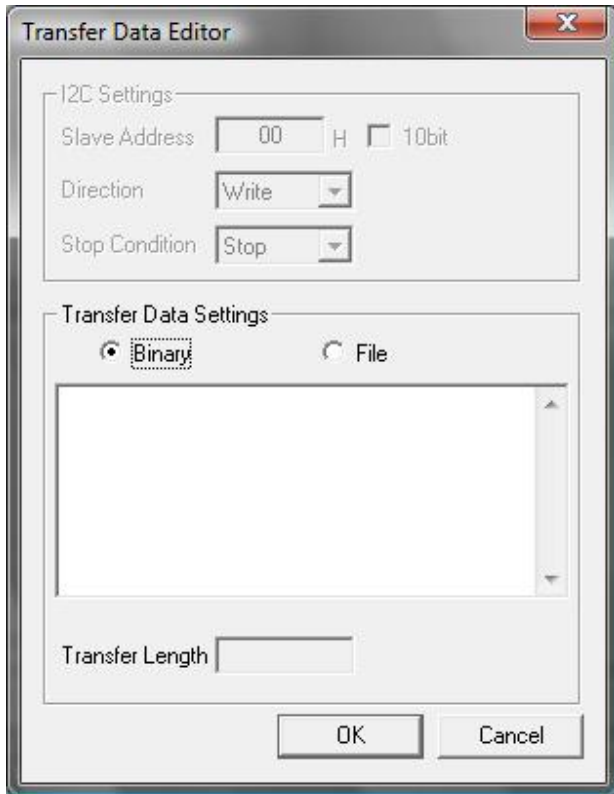

Fig3-4. SPI mode

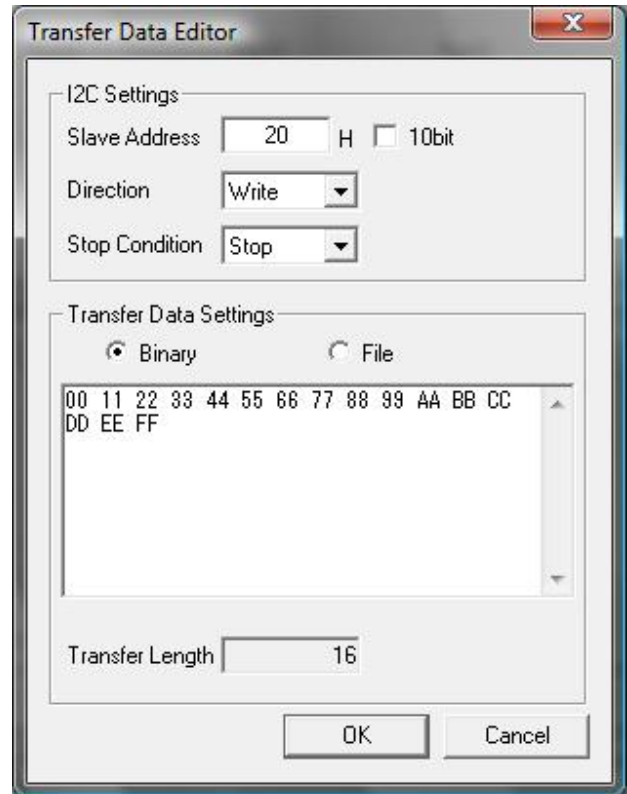

Fig3-5. I2C mode

- I2C setting : Set transfer setting for the I2C bus
 - ① Slave address : Set a device address in Hex number
N.B.) Refer to Page.4-16 for how to set an slave address.
 - ② 10bit : Put a check mark when you set 10 bit address
N.B.) Refer to Page.4-16 for how to set an slave address.
 - ③ Transfer direction : Set transfer direction. Set it as Read or Write.
 - ④ Stop condition : Set whether to issue stop condition.

- Transfer data setting : Display a content of transfer data or file name (in Hex number).
 - ① Set as a binary : At the edit box, input data which is directly sent
 - ② Set from a file : Set data from a binary file
 - ③ Select a file : Select a binary file
 - ④ Length of data transfer : Data size (in Decimal number)
(Max 65535 bytes)

Option setting

You can set the following by selecting [Option(O)] →[Setting].

- Set pull-up setting on the I2C bus
- Set to supply power to a target device
- Set an interval between data

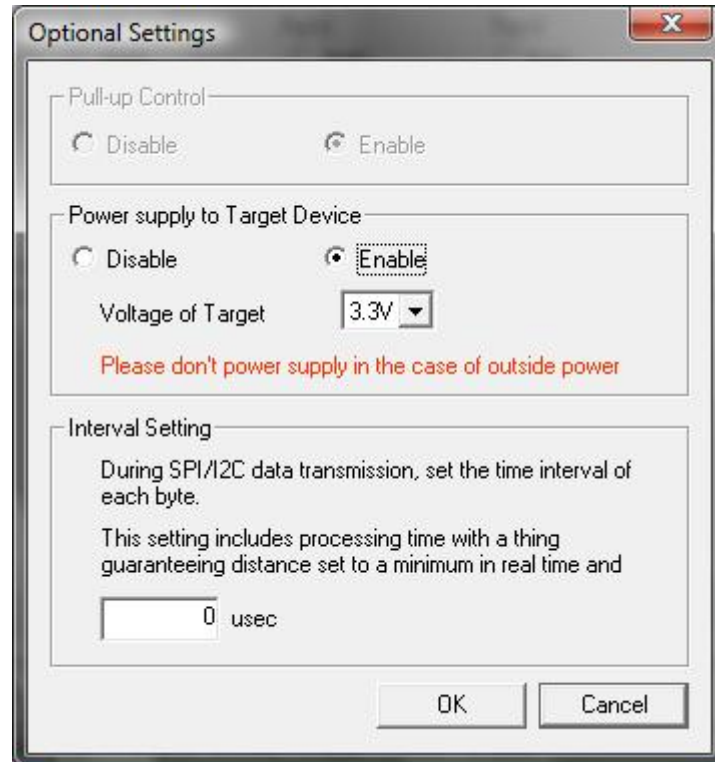

Fig3-6. Option setting window

- Disable/enable pull-up : Select whether to set pull-up on the I2C bus line.
(I2C at 5V, 1MHz pin [401KHz - 1000KHz] only can be selected.)
- Whether to supply power or not : Select whether to supply power to a target device. Select from 3.3V or 5.0V.
N.B. : Don't supply power while an external power supply provide power
- Set an interval : Set a time interval for 1 byte each when sending data.

(3-3) Example to control by using this utility

* The below explanation is an example used ATMEL:AT24C02B、 AT25080A

- SPI master mode

[Switch SPI/I2C]

By switching SPI/I2C, SPI Mode can be selected.

[Set a sampling rate(frequency)]

Set a sampling rate(frequency) at the Frequency section.

You can set a sampling rate(frequency) by 1KHz each. For SPI, a sampling rate(frequency) will be set at an approximate value which can be really set. (I2C:47KHz - 1MHz / SPI: Up to 12MHz)

For how to calculate an approximate value, please refer to a `usb61_spi_set_freq()` function at Chapter 4.

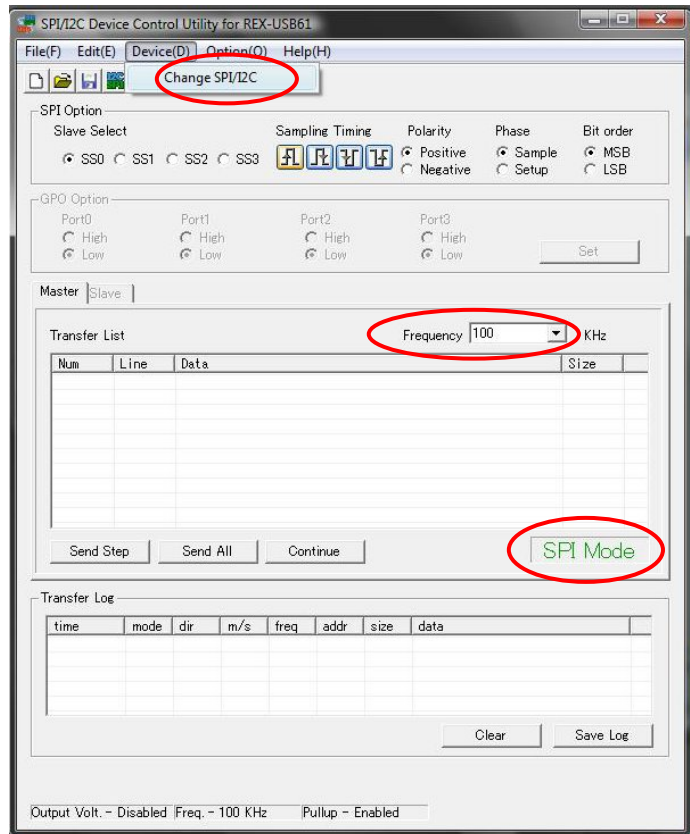

Fig3-7. Default setting of utility

[Set to supply power]

Supply power by selecting [Option]-[Setting].

[Set an interval]

Set a time interval by 1 byte each for sending data.

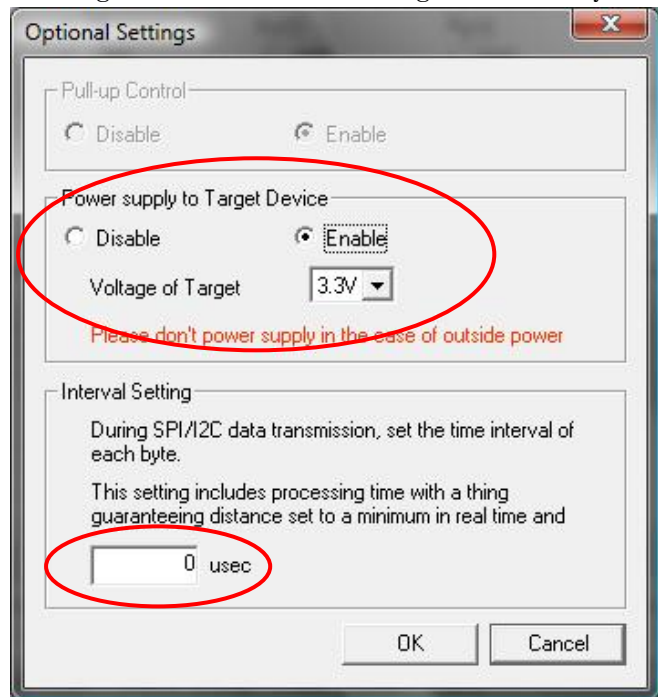

Fig3-8. Setting to supply power

Example : Write 11 22 33 44 55 66 77 88 at 50h, and write 8bytes data from 50h.

[Data input(Write / Read)]

Double-click an inside of [Transfer List] and input a Hex number.
Please see the below example.

- (1 row)
- 06h --- Set Write Enable bit
- (2 row)
- 02h --- Write command
- 00h 50h --- Address where data is written
- 11h 22h.. --- Data to be written (8byte)
- (3 row)
- 03h --- Read command
- 00h 50h --- Address to be read
- 00h 00h --- Dummy data for Read(8byte)
- (8byte data will be read)

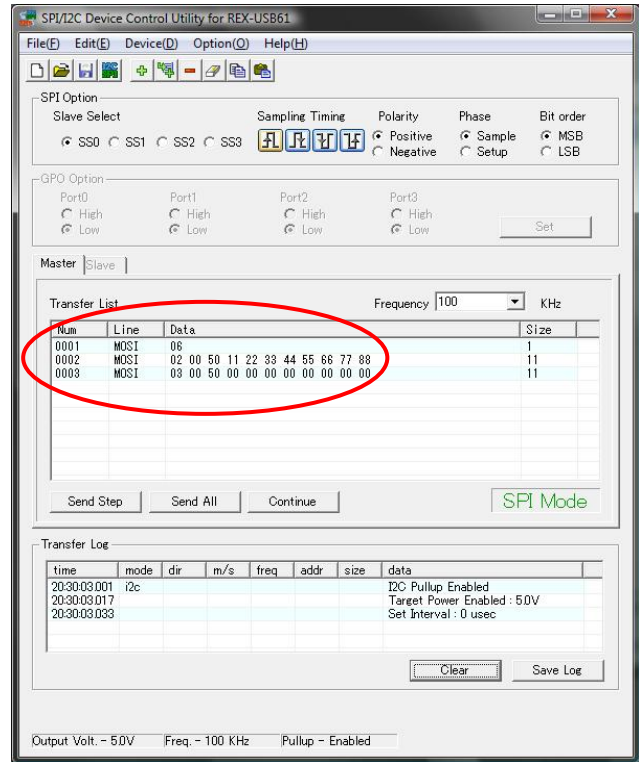

Fig3-9. data input

[Execution(Write / Read)]

By clicking the [Send All] button, the data inside of the [Transfer List] will be sent.

The sent/received data will be displayed at the [Transfer Log].

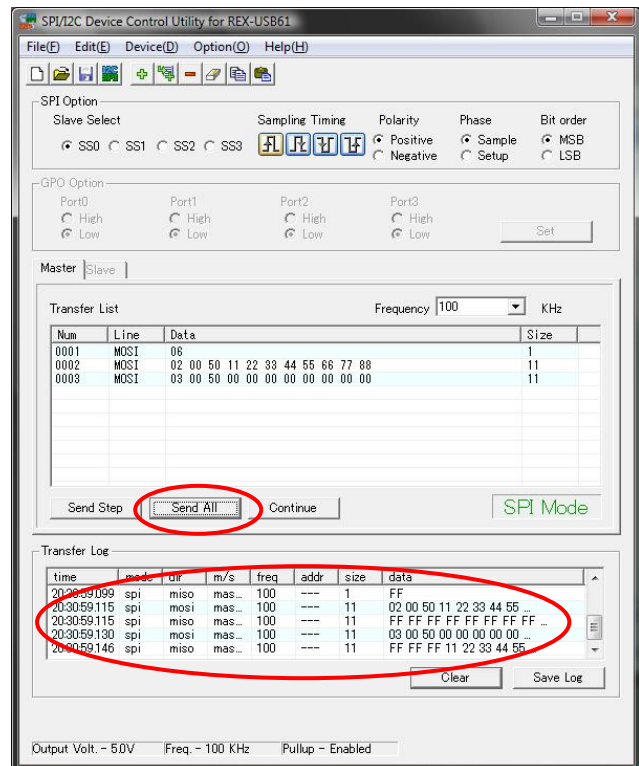

Fig3-10. Execution

- I2C master mode

[Switch SPI/I2C]

[Set a sampling rate(frequency)]

[Set to supply power]

[Set an interval]

Like the procedure described at Page.3-8,switch modes into I2C Mode and set a sampling rate(frequency) / power supply / interval. (Master tab should be selected)

***1 Slave address**

(R/W bit is not included)

[Example : In case of 50h]

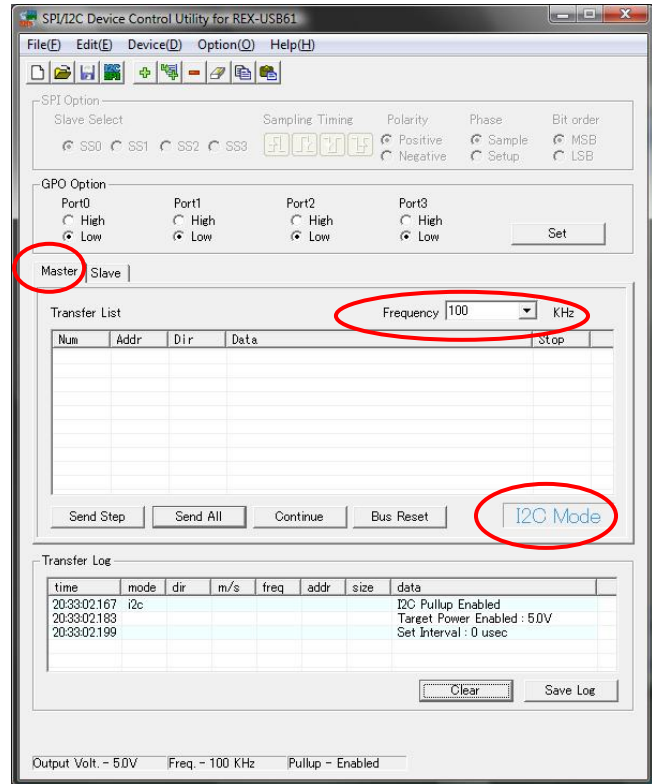
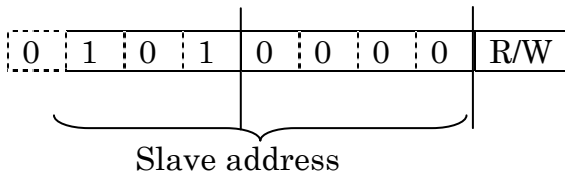

Fig3-11. initial setting of utility

Example : Write 11 22 33 44 at the address of 00h for a device of slave address 50h, and write 4byte data from the address of 00h for the device of address 50h.

[Data input(Write / Read)]

Double-click an inside of [Transfer List]

and set each item.

- slave address --- Set 7bit

*1 For setting, refer to [Slave address], as described above.

(If you set data as 10bit, put a check mark at the [10bit])

- Transfer direction --- Select Write / Read
- Stop condition --- Set an issue of stop condition
- Transfer data --- Set data in Hex number
- Length of data transfer --- When writing, the length of data transfer will be displayed automatically and when reading, set data size which will be read.(Unit:Byte)

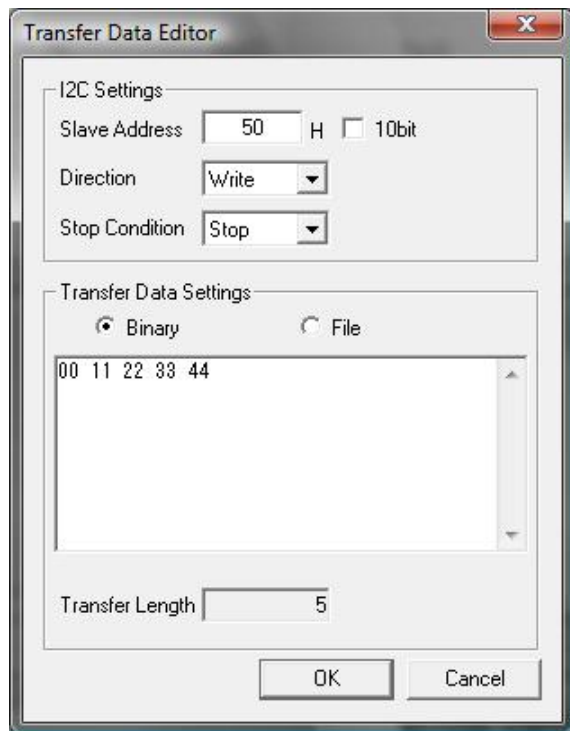

Fig3-12. Edit transfer data

Please see the below sample.

(1 row) <Write>

- Slave address --- 50 h (Set as 7bit)
- Data direction --- Write
- Stop condition ---Yes
- Transfer data
00h --- Address to be written
11h 22h.. --- Data to be written

(2 row) <Write for Read>

- Slave address --- 50 h (Set as 7bit)
- Data direction --- Write
- Stop condition --- No
- Transfer data
00h --- Address to be read

(3 row) <Read>

- Slave address --- 50 h (Set as 7bit)
- Data direction --- Read
- Stop condition --- Yes
- Length of data transfer --- 4
(This won't display)

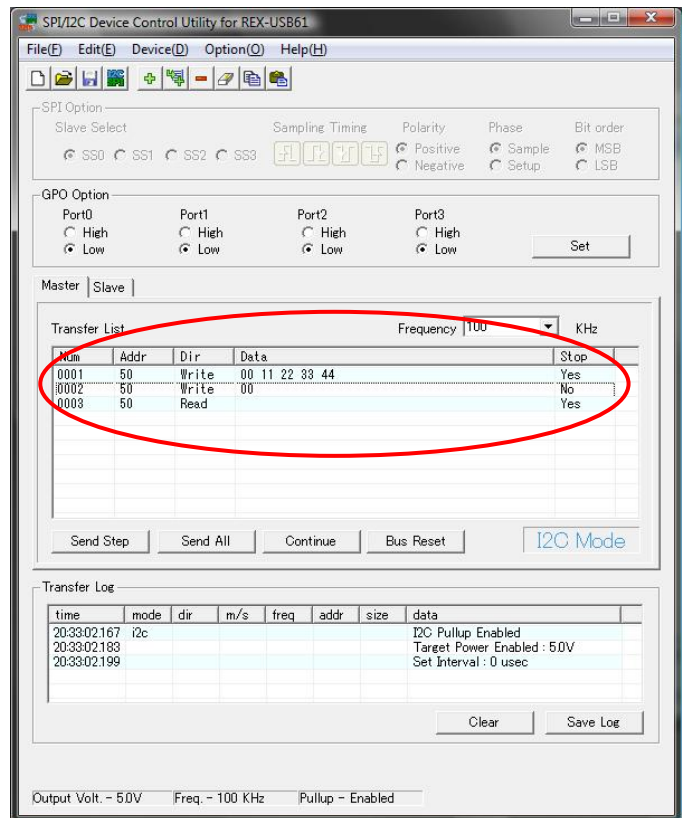

Fig3-13. Data input

[Execution(Write / Read)]

By clicking the [Send All] button, data inside of the [Transfer List] will be sent.

The sent/received data will be displayed at the [Transfer Log].

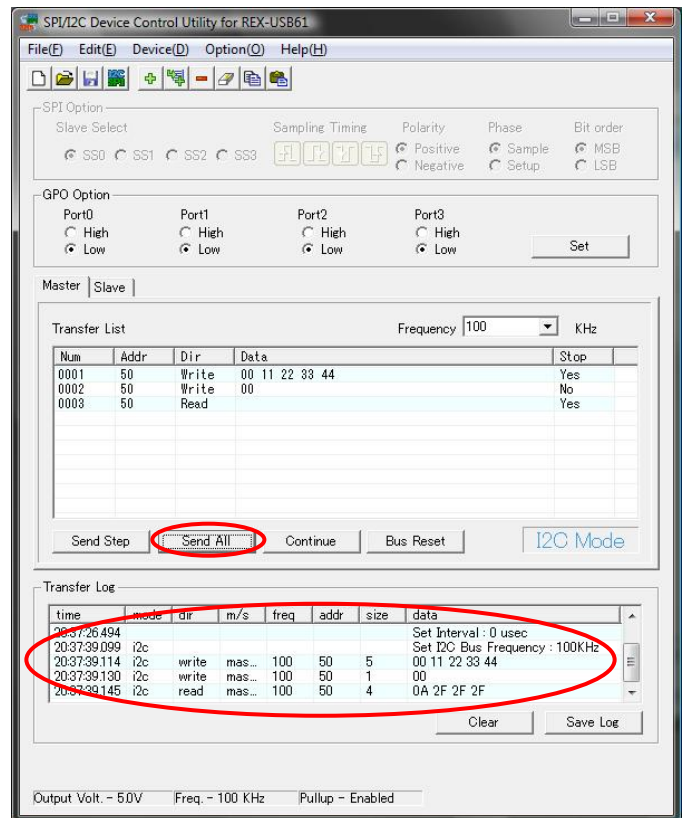

Fig3-14. Execution

- I2C slave mode

Example : Read data transferred to slave address 50h

[Switch SPI/I2C]

[Set a sampling rate(frequency)]

[Set to supply power]

[Set an interval]

Like the procedure described at Page.3-8,switch modes into I2C Mode and set a sampling rate(frequency) / power supply/interval. (Master tab should be selected)

Set a slave address as 7bit at the [Slave Address] and click the [Enable] button.

When data is sent from a master, Read data will be displayed at the [Response Data] and [Transfer log].

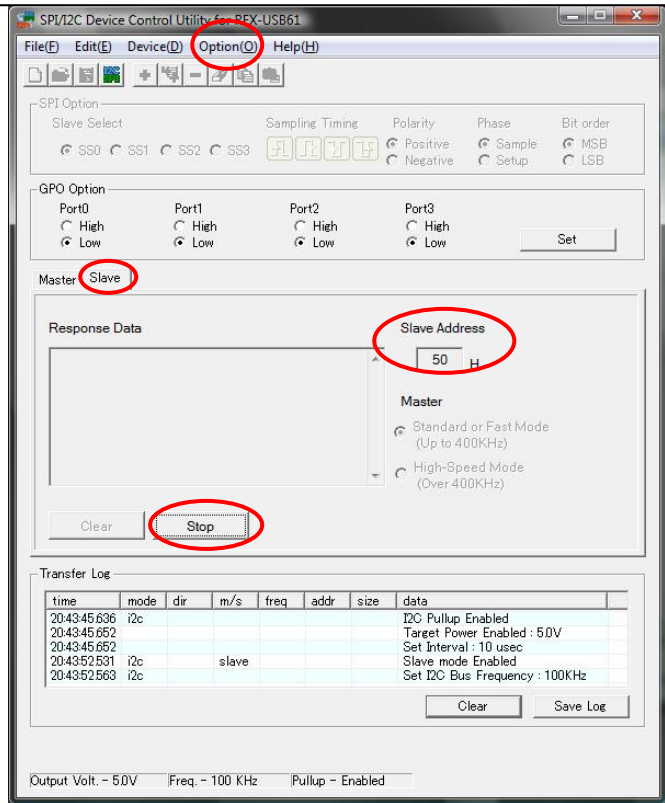

Fig3-15. I2C slave mode setting

(3-4) Grammar for script description

This utility can treat a script file where a description of a device access is written.

You can describe a comment at the script file. By using the script file, you can access a device. You need to describe a script by the following rule:

◆ Common command for SPI/I2C

The following is a common command for both SPI and I2C.

- **Definition of values**

Describe values as Decimal number or Hex number.

- The values ranges from 0~65536 and if the values is Hex number, put [h] or [H] at the end of the values. If you describe the values consecutively, put [,] between a value and another value.

- **Definition of characters**

This script file doesn't distinguish a small letter and a large letter of alphabet. You may write Japanese comments.

- **Grammar**

Be sure to put space(one-byte) or TAB between a command and another command, or a value and another value.

Two-byte characters are a grammatical error.

Fig.3-2 Common command table

Command	#						
Meaning	The sentence after [#] is treated as a comment.						
Parameter	None						
Command	MODE=						
Meaning	Set mode for SPI, or I2C. There is not a default value for this MODE command. If you don't set a mode, it is a grammatical error. After setting, you can not change modes halfway.						
Parameter	SPI I2C						
Command	FREQUENCY=						
Meaning	Set a sampling rate(frequency). You can set a sampling rate(frequency) by 1KHz each. For SPI, a sampling rate(frequency) will be set at an approximate value which can be really set. (I2C:47KHz - 1MHz / SPI: Up to 12MHz) * For how to calculate an approximate value, please refer to a <i>usb61_spi_set_freq()</i> function at Chapter 4. If you don't set Frequency, the following is a default value.						
	<table border="1"> <thead> <tr> <th>Mode</th> <th>Sampling rate (Frequency)</th> </tr> </thead> <tbody> <tr> <td>SPI</td> <td>100KHz</td> </tr> <tr> <td>I2C</td> <td>100KHz</td> </tr> </tbody> </table>	Mode	Sampling rate (Frequency)	SPI	100KHz	I2C	100KHz
Mode	Sampling rate (Frequency)						
SPI	100KHz						
I2C	100KHz						
	You can change sampling rate(frequency) any time.						
Parameter	You can set the below setting for SPI,I2C.						
	<table border="1"> <thead> <tr> <th>Mode</th> <th>Setting value</th> </tr> </thead> <tbody> <tr> <td>SPI</td> <td>1 - 12000</td> </tr> <tr> <td>I2C</td> <td>47 - 1000</td> </tr> </tbody> </table>	Mode	Setting value	SPI	1 - 12000	I2C	47 - 1000
Mode	Setting value						
SPI	1 - 12000						
I2C	47 - 1000						

Command	INTERVAL=
Meaning	Set an interval of waiting time which is inserted into bytes of data to be sent.(Unit: micro second) If you don't set this value, a default value is 0.
Parameter	Set a value ranging from 0 to 65535.(0 – 65535 micro seconds)
* An actual interval time include process time, so it will be longer than the interval set here.	

Command	POWER=	
Meaning	Supply power set at a parameter. You can change power supply any time. If you don't set this item, a default value is Output OFF.	
Parameter	Output	Setting value
	Output OFF	OFF
	Output 3.3V	ON3
	Output 5.0V	ON5

Command	WAIT=
Meaning	Set a waiting time until a next command is executed. Unit is 100 milliseconds. (100 milliseconds - 60 seconds)
Parameter	Set a value ranging from 1 to 600. (100milliseconds - 60 seconds)

Command	REPEAT=nn
Meaning	Repeat a command written in { } after REPEAT command by a number set in this command. If this { } is not written, only a next command written right after this command will be repeated. * For how to use this command, please refer to Page.3-17.
Parameter	nn=1 - 65536{...}

Command	PULLUP=
Meaning	Set a pull-up setting for SDA, SCL signal line. A default value is pull-up(ON), and as long as voltage of power supply:5V,frequency:1MHz is set, you can set off pull-up.
Parameter	ON or OFF

Command	FILEn
Meaning	Set a file number as n, and you can set 5 files at maximum. From a file embraced by""(double-quotation), data will be sent/received. Data is treated as binary data. To set a file, appoint a file name instead of path. Please note error happens if the file doesn't exist at the same directory when sending data. When receiving data, a new file will be created.
Parameter	n=1 - 5 "file name"

Command	END
Meaning	Execute the script until END. The content described after END isn't executed. (Reading script will stop at END command)
Parameter	None



◆ Command for I2C only

Fig.3-3 I2C command table

Command	ADDRESSMODE=			
Meaning	Set I2C address to 7 bit mode or 10 bit mode. (Default value is 7 bit mode)			
Parameter	7 or 10			
Command	ADDRESS=			
Meaning	Set I2C address You can change address any time, but if [READ] or [WRITE] command is written before setting an address, it is a grammatical error.			
Parameter	0 – 1023			
Command	READ			
Meaning	Read bytes set by this command.			
Parameter	xxH Set bytes which will be read. 1 - 65536			
Command	READF			
Meaning	Read bytes set by this command and save the data as a file. The data is saved as a file name described as FILEn. Add the data to the existing file if a file already exist.			
Parameter	xxH FILEn Set bytes to be read, a file to be saved (Bytes:1 - 65536)			
Command	WRITE			
Meaning	Write data set by this command. If more than one data need to be written, separate each data by comma.			
Parameter	xxH, xxH, ... Set data to be written by bytes.			
Command	WRITEF			
Meaning	Send data from a file. Data is treated by a binary data. Data to be written is read from a file specified as FILEn.			
Parameter	FILEn Set a file to be written			
Command	STOP			
Meaning	Send stop bit.			
Parameter	None			
Command	RESET			
Meaning	Issue a reset to bus(send STOP bit)			
Parameter	None			
Command	GPO=			
Meaning	Set a port output to DO0 - DO3(#13 - #16 pin)			
Parameter	Set 1 for output bit. Set 0 - 15 when describing in Decimal number. Set 0h - Fh when describing in Hex number.			
	Bit3	Bit2	Bit1	Bit0
	DO3	DO2	DO1	DO0

◆ Command for SPI only

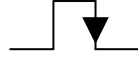
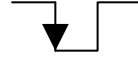
Fig.3-4 SPI command table

Command	SS=n		
Meaning	Set slave select pin. Default value is 0.		
	Parameter	SSx	
	0	SS0	
	1	SS1	
	2	SS2	
	3	SS3	
Parameter	n=0 - 3		
Command	SAMPLING=n		
Meaning	Set bus sampling method. Default value is 0.		
	Parameter	Sampling edge	Figure
	0	Rising edge	
	1	Falling edge	
	2	Falling edge	
	3	Rising edge	
Parameter	n=0 - 3		
Command	FB=		
Meaning	Set a first bit. Default value is MSB.		
Parameter	MSB or LSB		
Command	SSSET		
Meaning	Set Low for slave select signal set by SS command.		
Parameter	None		
Command	SSRESET		
Meaning	Set High for slave select signal set by SS command.		
Parameter	None		

Other functions	
For SPI, there isn't any particular command for Read/Write, and write a described value. SPI by its nature write and read at the same time, so to read only isn't allowed.	
Meaning	Read data is saved as a file set in FILEn.(If FILEn is specified) Add data if an existing file is set.
Parameter	xxH, xxH, ... FILEn Set data to be written by bytes, and data to be read is saved as a File.
Meaning	Write data from a file set by FILEm. Read Data is saved as a file set by FILEn.(If FILEn is specified) Add data if an existing file is set.
Parameter	FILEm FILEn Set data to be written as a file, and save data to be read as a file.

◆ How to use REPEAT command

This section explains REPEAT script and inside process of { } and STOP.

Script code	Explanation of function
REPEAT=10 READ 1 STOP	After receiving 10 bytes of data, STOP condition is sent.
REPEAT=10 { READ 1 STOP }	Repeat the following 10 times: [Send STOP condition by 1 byte each]
REPEAT=10 READ 1 STOP	STOP condition is sent after receiving 10 bytes of data.
REPEAT=10 { READ 1 } STOP	STOP condition is sent after receiving 10 bytes of data.
REPEAT=10 { READ 1 STOP }	Repeat the following 10 times: [STOP condition is sent after receiving 1 byte of data]

(3-5) Example of script

The below is an explanation of how to use a script file.

From [Option]-> [List View/Script Change], show script description mode.

The function of each button is as follows:

- [Load] --- Read a script file.
- [Save] --- Save a script file.
- [Clear]--- Erase a shown content.
- [Execute]---Execute a script.
- [Stop]--- Stop executing script.

A result of execution shows at [Transfer Log].

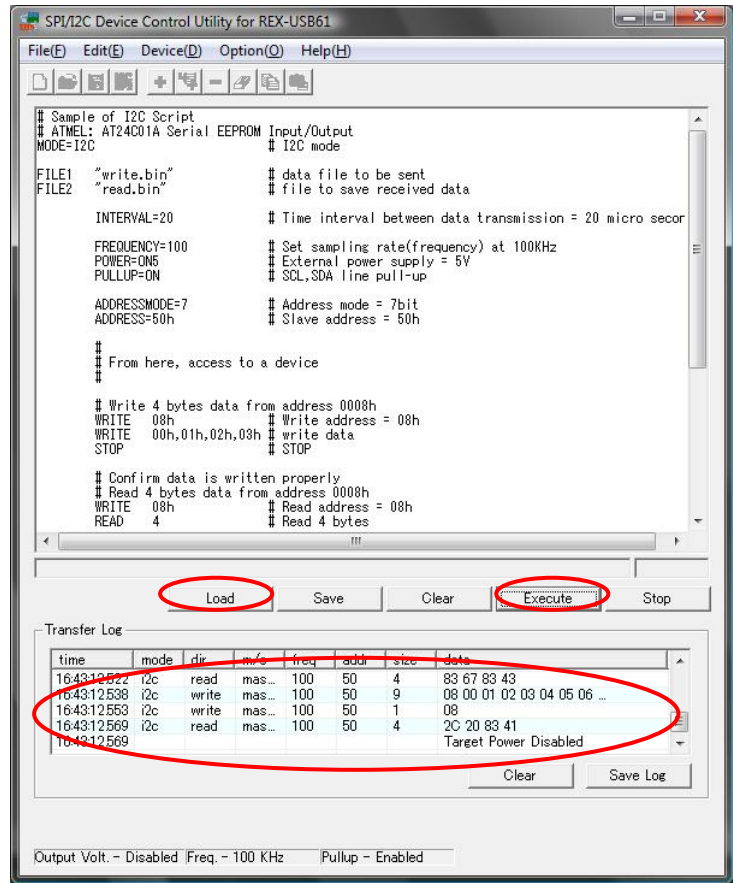

Fig3-16. Example of script

* You can make and edit a script file with a text editor because script files are text files.

The below describes script samples(Write/Read) to control an I2C and SPI device.

(The script files are included at the bundled CD-ROM. I2C_script.txt/ SPI_script.txt)

• **Sample of I2C script : (Write 4bytes data(00h 01h 02h 03h) from the address of 08h of the device at slave address 50h, and read the data to confirm the data is written properly. And also, write data on the file, and read the data to a file to confirm the data is written. Sampling rate(frequency) is 100KHz/External power supply is 5V)**

```
# Sample of I2C script
# ATMEL: AT24C01A Serial EEPROM  Input/Output
MODE=I2C                # I2C mode

FILE1 "write.bin"      # data file to be sent
FILE2 "read.bin"       # file to save received data

INTERVAL=20            # Time interval between data transmission 20 μ sec.
FREQUENCY=100          # Set sampling rate(frequency) at 100KHz.
POWER=ON5              # External power supply 5V
PULLUP=ON              # SCL,SDA line pull-up
ADDRESSMODE=7         # Address mode 7 bit
ADDRESS=50h           # Slave address 50h

#
# From here, access to a device
#

# Write 4 bytes data from address 0008h
WRITE 08h              # Write address 08h
WRITE 00h,01h,02h,03h # Write data
STOP                  # STOP

# Confirm data is written properly
# Read 4 bytes data from address 0008h
WRITE 08h              # Read address 08h
READ 4                 # Read 4 bytes
STOP                  # STOP

# Read data of FILE1 from address 0008h
WRITE 08h              # Write address 08h
WRITEF FILE1          # Write data(4 bytes of binary data at FILE1)
STOP                  # STOP

# Confirm data is written properly
# Copy data read from address 0008h onto FILE2
WRITE 08h              # Read address 08h
READF 04h FILE2       # Copy 4 bytes read data onto FILE2
STOP                  # STOP

POWER=OFF              # External power supply 0V

END
```

• **Sample of SPI script : (Write 4bytes data(00h 01h 02h 03h) from the address of 15h, and read the data to confirm the data is written properly. And also, write data on the file, and read the data to a file to confirm the data is written. Sampling rate(frequency) is 3MHz/External power supply is 5V)**

```
# Sample of SPI script
# ATMEL: AT25080 Serial EEPROM  Input/Output

MODE=SPI          # SPI mode

FILE1  "write.bin"      # data file to be sent
FILE2  "read.bin"      # file to save received data

POWER=ON5          # External power supply 5V
INTERVAL=20        # Time interval between data transmission 20 μ sec.

FREQUENCY=3000     # Set sampling rate(frequency) at 3MHz.
SAMPLING=0         # Specify an edge to renew data
FB=MSB             # Set a bit order
SS=0               # Select slave select pin as 0

#
# From here, access to a device
#

# Write 4 bytes data from address 0015h
SSSET              # Activate SS signal at the Low level
06h                # Operation code WREN
SSRESET           # Activate SS signal at the High level
SSSET              # Activate SS signal at the Low level
02h,15h,00h       # Operation code WRITE+ write address
00h,01h,02h,03h   # Write data
SSRESET           # Activate SS signal at the High level

# Confirm data is written properly
# Read 4 bytes data from address 0015h
SSSET              # Activate SS signal at the Low level
03h,15h,00h       # Operation code READ+ read address
REPEAT=4           # Repeat the next command 4 times
00h                # Read 1 byte of dummy data
SSRESET           # Activate SS signal at the High level

# Write data on FILE1 from address 0015h
SSSET              # Activate SS signal at the Low level
06h                # Operation code WREN
SSRESET           # Activate SS signal as the High level
SSSET              # Activate SS signal at the Low level
02h,15h,00h       # Operation code WRITE+ write address
FILE1             # Write data on FILE1
SSRESET           # Activate SS signal at the High level
```

(Continue to the following page)

4. API function reference

(4-1) Using on VC

This API functions is a library software to support software development using REX-USB61.

By using the API functions, it will be possible to incorporate the application program own control SPI/I2C target device.

The header file (usb61def.h) and the library file (usb61api.lib, usb61spi.dll) are provided to use the library functions on VC++.

Add these files to your project, then call the library functions.

The declaration of importing library functions is as follows (excerpt from usb61def.h):

* For a description of user defined types, please see the header file usb61def.h.

```
#define USB61LIB_API __declspec(dllimport)

USB61LIB_API HANDLE WINAPI usb61_open( RS_STATUS *pStatus );
USB61LIB_API RS_STATUS WINAPI usb61_close( HANDLE hUsb61Device );
USB61LIB_API RS_STATUS WINAPI
    usb61_power_control( HANDLE hUsb61Device, UINT fPowerState );
USB61LIB_API RS_STATUS WINAPI
    usb61_mode_change( HANDLE hUsb61Device, UINT fDeviceMode,
        USHORT i2cSlaveAddr );
USB61LIB_API RS_STATUS WINAPI
    usb61_set_interval( HANDLE hUsb61Device, USHORT IntervalCnt );
USB61LIB_API RS_STATUS WINAPI
    usb61_gpo_write( HANDLE hUsb61Device, UINT fPortVal );
USB61LIB_API RS_STATUS WINAPI
    usb61_get_fw_version( HANDLE hUsb61Device, UCHAR* pFWMajorVer,
        UCHAR* pFWMinorVer );
USB61LIB_API RS_STATUS WINAPI
    usb61_get_dll_version( HANDLE hUsb61Device, UCHAR* pDllMajorVer,
        UCHAR* pDllMinorVer );
USB61LIB_API RS_STATUS WINAPI
usb61_get_hw_info( HANDLE hUsb61Device, RS_HARDWARE_INFO pHardwareInfo );
USB61LIB_API RS_STATUS WINAPI
    usb61_i2c_pullup( HANDLE hUsb61Device, RS_I2C_PULLUP fI2cPullup );
USB61LIB_API RS_STATUS WINAPI usb61_i2c_bus_reset( HANDLE hUsb61Device );
```

(Continue to the following page)

(4-2) Using on VB / Visual C#

To use an ActiveX component that is attached to a product from application of Visual C# and Visual BASIC, you need to register your ActiveX by following method.

(1) Registration of ActiveX

Install the driver in Chapter 2 Windows Setup.
The DLL and ActiveX will be copied automatically.
For using the usb61api.ocx on VB, use the tool "Regsvr32.exe" that is attached to the Visual BASIC.
The "Regsvr32.exe" is 32bit console application. Therefore you must run it on command prompt.
When register "usb61api.ocx", enter on command prompt as the follows:
> regsvr32 usb61api.ocx
* On Windows 7/Vista, you have to start the command which run as administrator.

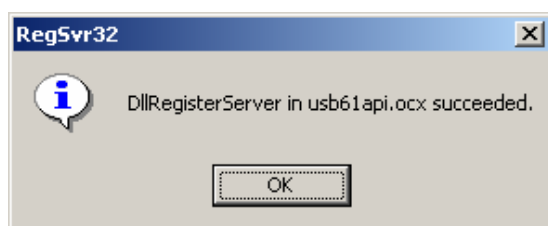

The message of registration success.

(2) Unregistration of ActiveX

When unregister it, enter on command prompt as the follows:
> regsvr32 /u usb61spi.ocx

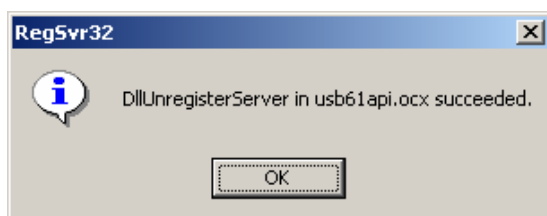

The message of unregistration success.

(3)How to reference ActiveX on VB6

Create new project.

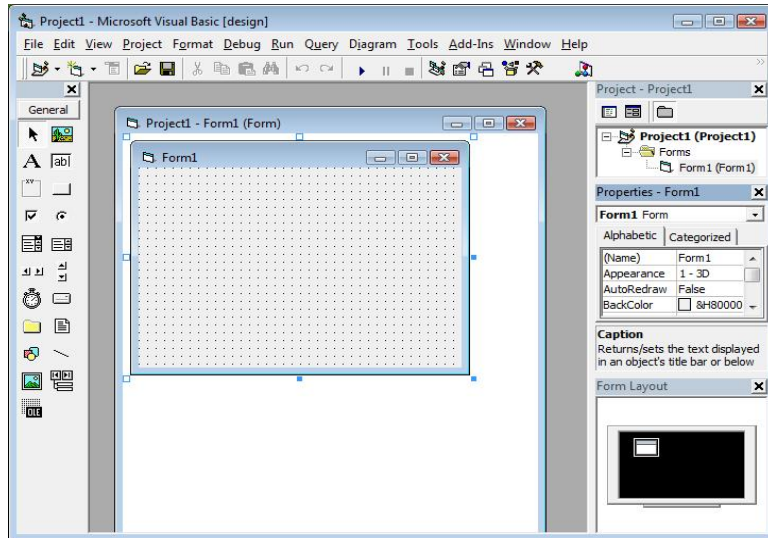

Select the component with the Project menu.

Check-in the "usb61spi ActiveX Control Module" in the list of controls. Click "OK" button.

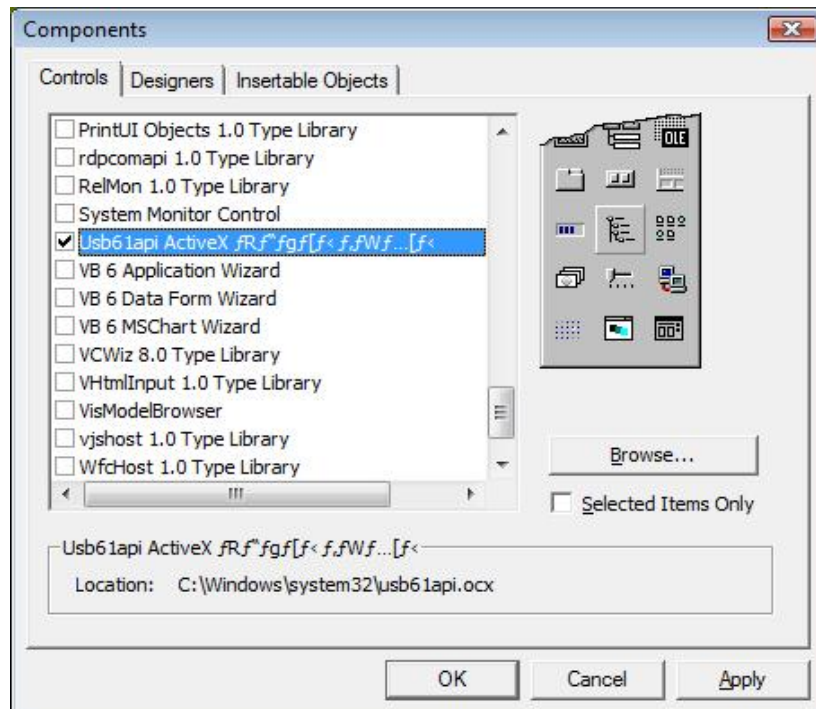

Then the usb61spi Active X component is added.

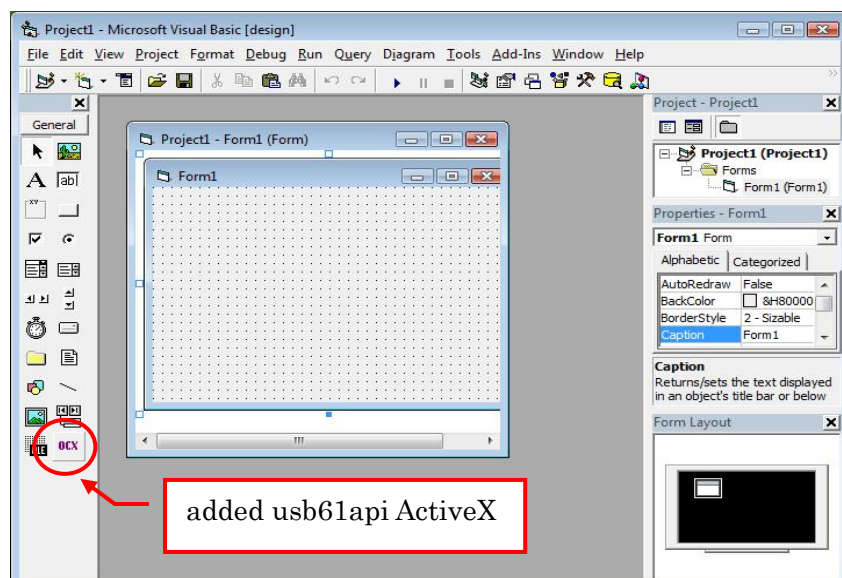

Select the usb61api Active X component that was added, and then paste the project to the form. To prevent appear on the run-time, set the "Visible" in the property of the object to false.

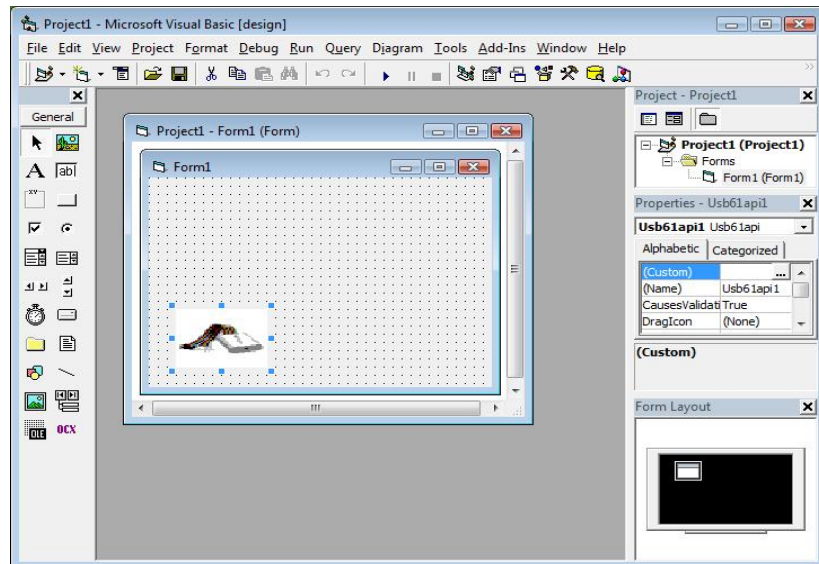

Double-click the object, then appear the subroutine "Sub Usb61api1_OnEventMsg(...)" that called at when event occurs.

See the description of the "Detail of API functions".

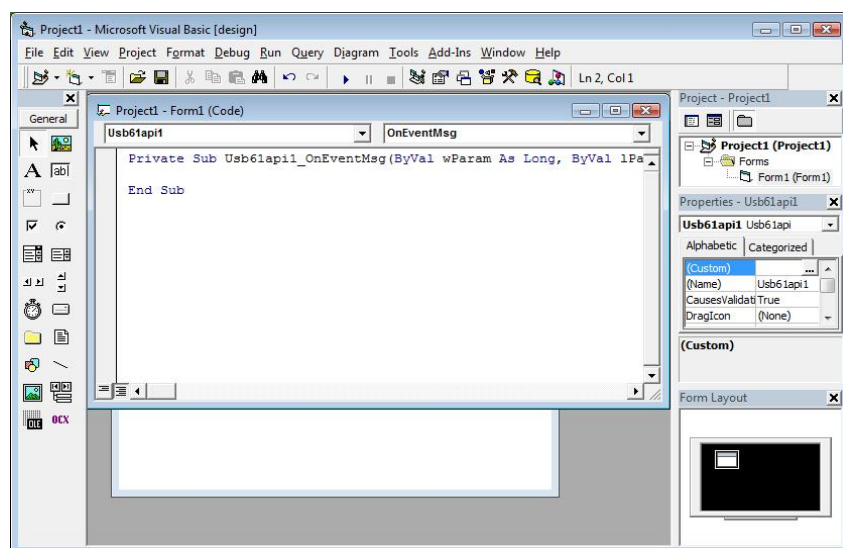

(4)How to reference ActiveX on VB.NET / Visual C#

Create new project.

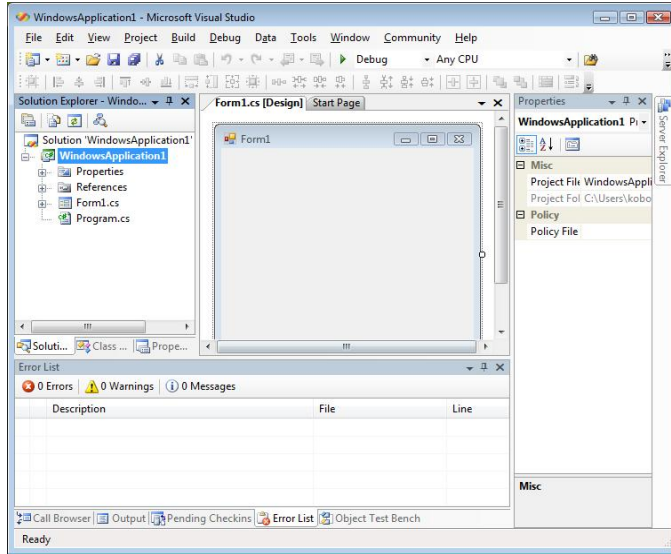

Select the [Tool] - [Choose Toolbox Items...] - [COM Components] in the menu. Check the [Usb61apiControl]. Then click the "OK" button.

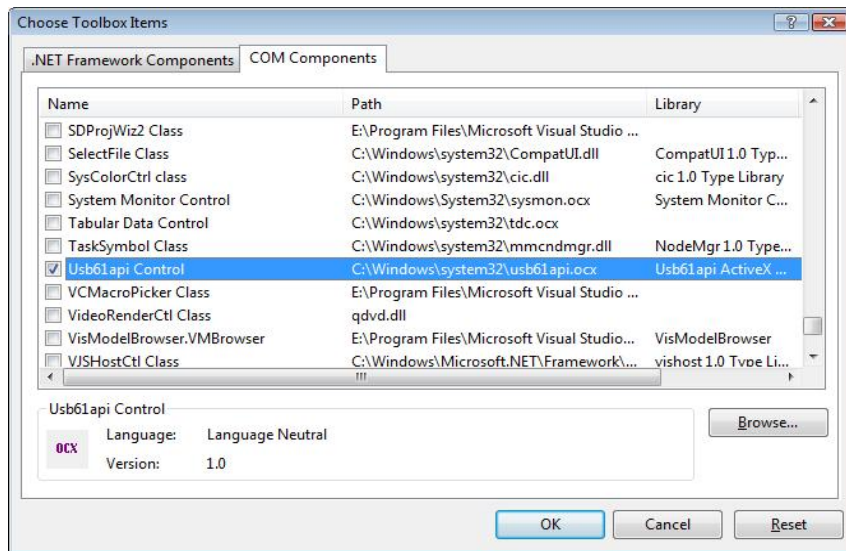

Confirm the component is registered, then paste to the form.

To prevent appear on the run-time, set the "Visible" in the property of the object to false.

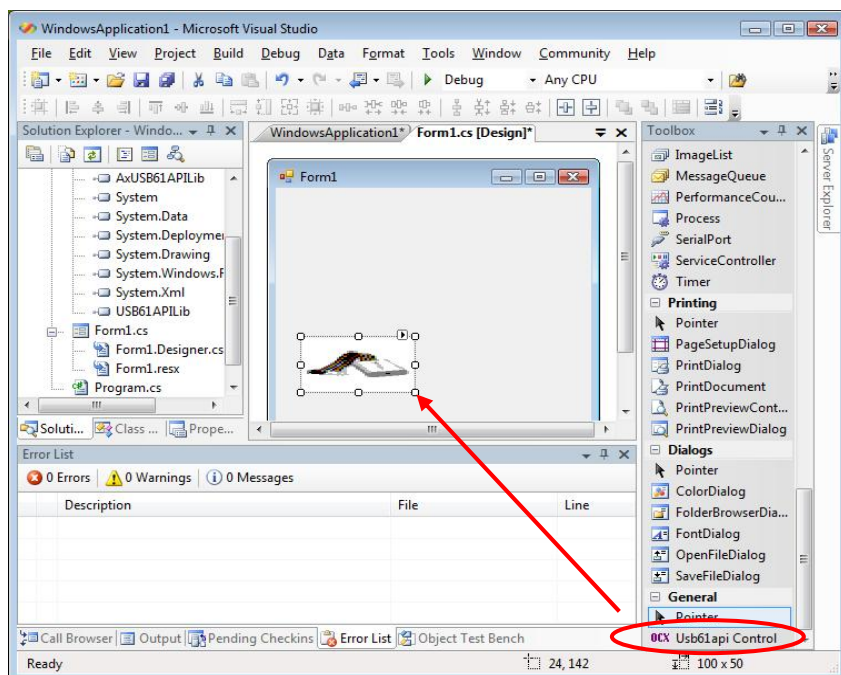

Double-click the object, then appear the subroutine "Sub Usb61api1_OnEventMsg(...)" that called at when event occurs.

See the description of the "Detail of API functions".

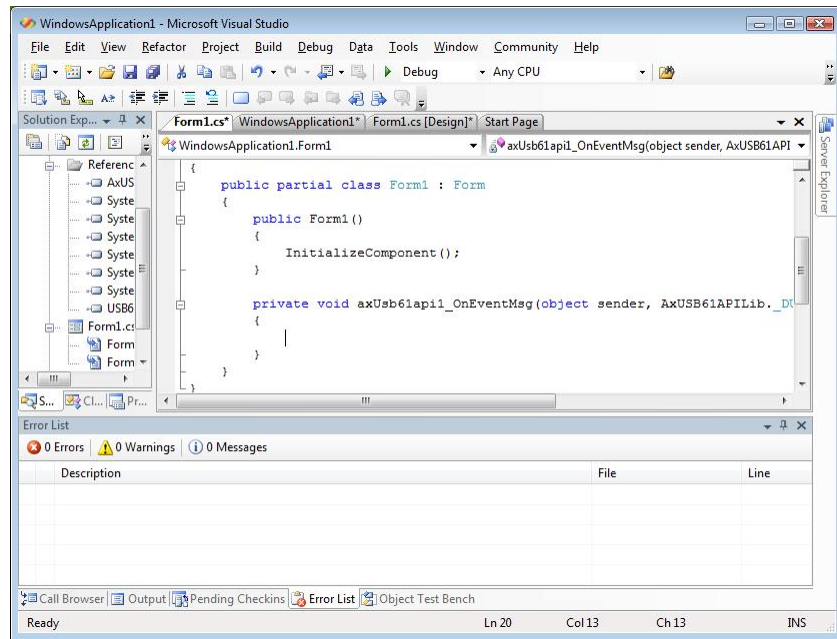

(4-3) List of API functions

The list of API functions is as the below:

Table 4-1. API Function Names and Descriptions

Function name	Description
usb61_open()	Open the REX-USB61 device
usb61_close()	Close the REX-USB61 device.
usb61_power_control()	Control the supply power to the device
usb61_get_fw_version()	Get the version number of firmware
usb61_get_dll_version()	Get the version number of DLL
usb61_get_hw_info()	Retrieve the hardware information for the SPI/I2C bus operation
usb61_mode_change()	Configure SPI/I2C mode and Master/Slave operation
usb61_set_interval()	Configure the interval time of sending byte data to the SPI/I2C bus
usb61_gpo_write()	Output to the GPO pin on I2C mode
usb61_i2c_pullup()	Set pullup on I2C bus (Each pin of SDA and SCL)
usb61_i2c_bus_reset()	Reset I2C bus
usb61_i2c_set_freq()	Configures I2C bus frequency
usb61_i2c_set_freq_ex()	Configures the I2C bus frequency in kilohertz
usb61_i2c_read_master()	Read a stream of bytes from the I2C slave device
usb61_i2c_read_master_ex()	Read a stream of bytes from the I2C slave device with sub-address
usb61_i2c_write_master()	Write a stream of bytes to the I2C slave device
usb61_i2c_read_slave()	Read a stream of bytes from the I2C master device
usb61_i2c_set_response_data()	Set the data for sending to master device on I2C slave mode
usb61_spi_set_freq()	Set the SPI bus frequency in kilohertz
usb61_spi_transmit_master()	Write a stream of bytes to the downstream SPI slave device *After write, set SS line status to High
usb61_spi_transmit_master_hold_ss()	Write a stream of bytes to the downstream SPI slave device *After write, not set SS line status to High

(4-4) Detail of API functions

The detail of API functions is as the below.

(See the VB6 sample "EEPROMRWUty" and the VB/C# sample "EEPROMRWUtyCS", for the calling method and the definition of function without the use of ActiveX on VB/C#.)

General Functions

Definition	VC	HANDLE usb61_open(RS_STATUS *pStatus);	
	VB	Function Usb61Open (pStatus As Long) As Long	
	VB.NET	Function Usb61Open (ByRef pStatus As Integer) As Integer	
Description	Open the REX-USB61 device. Start for using the REX-USB61 device.		
Parameters	[OUT] pStatus : RS_SUCCESS	Function call succeeded.	
		Error code (refer. 4-5)	Function call failed.
Return Values	Handle of an REX-USB61 device	Function call succeeded.	
	INVALID_HANDLE_VALUE	Function call failed.	

Definition	VC	RS_STATUS usb61_close(HANDLE hUsb61Device);
	VB	Function Usb61Close (ByVal hUsb61Device As Long) As Long
	VB.NET	Function Usb61Close (ByVal hUsb61Device As Integer) As Integer
Description	Close the REX-USB61 device. Finish using the REX-USB61 device.	
Parameters	[IN] hUsb61Device : handle of an REX-USB61 device	
Return Values	RS_SUCCESS	Function call succeeded.
	Error code (refer. 4-5)	Function call failed.

Definition	VC	RS_STATUS usb61_power_control(HANDLE hUsb61Device, UINT fPowerState);
	VB	Function Usb61PowerControl (ByVal hUsb61Device As Long, ByVal fPowerState As Long) As Long
	VB.NET	Function Usb61PowerControl (ByVal hUsb61Device As Integer, ByVal fPowerState As Integer) As Integer
Description	Control the supply power to the device	
Parameters	<p>[IN] hUsb61Device : handle of an REX-USB61 device</p> <p>[IN] fPowerState : Enabled / Disabled supply power and the voltage of power</p> <p>Set the value of bit operation by using the defined symbol as the following:</p> <p>RS_PWRCTRL_ON, RS_OUTPUT_3_3V, RS_OUTPUT_5_0V</p> <p>And describe the value of bit-mask as the below:</p> <p>RS_PWRCTRL_OFF Disable supply power.</p> <p>RS_PWRCTRL_ON RS_OUTPUT_3_3V Enable supply power and the voltage is 3.3V.</p> <p>RS_PWRCTRL_ON RS_OUTPUT_5_0V Enable supply power and the voltage is 5.0V.</p>	
Return Values	RS_SUCCESS	Function call succeeded.
	Error code (refer. 4-5)	Function call failed.

Definition	VC	RS_STATUS usb61_get_fw_version(HANDLE hUsb61Device, UCHAR *pFwMajorVer, UCHAR *pFwMinorVer);
	VB	Function Usb61GetFwVersion(ByVal hUsb61Device As Long, pFWMajorVer As Byte, pFWMajorVer As Byte) As Long
	VB.NET	Function Usb61GetFwVersion(ByVal hUsb61Device As Integer, ByRef pFWMajorVer As Byte, ByRef pFWMajorVer As Byte) As Integer
Description	Get the version number of firmware	
Parameters	<p>[IN] hUsb61Device : handle of an REX-USB61 device</p> <p>[OUT] *pFwMajorVer : Pointer to major version number of Firmware (Hex-decimal)</p> <p>[OUT] *pFwMinorVer: Pointer to minor version number of Firmware (Hex-decimal)</p>	
Return Values	RS_SUCCESS	Function call succeeded.
	Error code (refer. 4-5)	Function call failed.

Definition	VC	RS_STATUS <code>usb61_get_hw_info(HANDLE hUsb61Device, PRR_HARDWARE_INFO pHardwareInfo);</code>
	VB	Function <code>Usb61GetHwInfo(ByVal hUsb61Device As Long, pHardwareInfo As Byte) As Long</code>
	VB.NET	Function <code>Usb61GetHwInfo(ByVal hUsb61Device As Integer, ByRef pHardwareInfo As Object) As Integer</code>
Description	Retrieve the hardware information for the SPI/I2C bus operation	
Parameters	<p>[IN] hUsb61Device : handle of an REX-USB61 device [OUT] pHardwareInfo : pointer to _RS_HARDWARE_INFO structure</p> <p>The _RS_HARDWARE_INFO structure is described bellow:</p> <pre>typedef struct _RS_HARDWARE_INFO { UCHAR DeviceMode; // SPI/I2C mode UCHAR MasterSlaveAct; // Master/Slave operation USHORT Frequency; // frequency of interface UCHAR OutputVolt; // Output voltage for target device } RS_HARDWARE_INFO, *PRR_HARDWARE_INFO;</pre> <p>_RS_HARDWARE_INFO structure is defined in usb61def.h.</p> <p>sample code for VB as the dellow:</p> <pre>Dim pHardWareBuf() As Byte Dim HardWareInfo As RS_HARDWARE_INFO ReDim pHardWareBuf(10) As Byte rsStatus = Usb61api.Usb61GetHwInfo(m_hDeviceHandle, pHardWareBuf) If rsStatus <> RS_SUCCESS Then ' error process Else HardWareInfo.DeviceMode = pHardWareBuf(0) HardWareInfo.MasterSlaveAct = pHardWareBuf(1) HardWareInfo.Frequency = pHardWareBuf(3)*256 + pHardWareBuf(2) HardWareInfo.OutputVolt = pHardWareBuf(4) End If</pre>	
Return Values	RS_SUCCESS	Function call succeeded.
	Error code (refer. 4-5)	Function call failed.

Definition	VC	RS_STATUS usb61_mode_change(HANDLE hUsb61Device, UINT fDeviceMode, USHORT i2cSlaveAddr);								
	VB	Function Usb61ModeChange(ByVal hUsb61Device As Long, ByVal fDeviceMode As Long, ByVal i2cSlaveAddr As Integer) As Long								
	VB.NET	Function Usb61ModeChange(ByVal hUsb61Device As Integer, ByVal fDeviceMode As Integer, ByVal i2cSlaveAddr As Short) As Integer								
Description	Configure SPI/I2C mode and Master/Slave operation.									
Parameters	<p>[IN] hUsb61Device : Handle of an REX-USB61 device</p> <p>[IN] fDeviceMode : Device mode setting bits</p> <p>Set the value of bit operation by using the defined symbol as the following:</p> <table style="margin-left: 40px;"> <tr> <td>RS_DEVMODE_SPI</td> <td>SPI mode</td> </tr> <tr> <td>RS_DEVMODE_I2C</td> <td>I2C mode</td> </tr> <tr> <td>RS_DEVMODE_MASTER</td> <td>Master operation</td> </tr> <tr> <td>RS_DEVMODE_SLAVE</td> <td>Slave operation</td> </tr> </table> <p>Example:</p> <p style="margin-left: 40px;">RS_DEVMODE_SPI RS_DEVMODE_MASTER (SPI master)</p> <p>[IN] i2cSlaveAddr : Address of I2C target device, when set I2C slave mode.</p>		RS_DEVMODE_SPI	SPI mode	RS_DEVMODE_I2C	I2C mode	RS_DEVMODE_MASTER	Master operation	RS_DEVMODE_SLAVE	Slave operation
RS_DEVMODE_SPI	SPI mode									
RS_DEVMODE_I2C	I2C mode									
RS_DEVMODE_MASTER	Master operation									
RS_DEVMODE_SLAVE	Slave operation									
Return Values	RS_SUCCESS	Function call succeeded.								
	Error code (refer. 4-5)	Function call failed.								

Definition	VC	RS_STATUS usb61_set_interval(HANDLE hUsb61Device, USHORT IntervalCnt);
	VB	Function Usb61SetInterval(ByVal hUsb61Device As Long, ByVal IntervalCnt As Long) As Long
	VB.NET	Function Usb61SetInterval(ByVal hUsb61Device As Integer, ByVal IntervalCnt As Integer) As Integer
Description	<p>Configure the interval time of sending byte data to the SPI/I2C bus. (a micro-second unit)</p> <p>* The actual interval is longer than the time set, because includes processing time. (If do not call this function, then actual interval is 0 micro-second)</p> <p>* Need to call usb61_mode_change(), before calling this function.</p>	
Parameters	<p>[IN] hUsb61Device : handle of an REX-USB61 device</p> <p>[IN] IntervalCnt : Interval for send data (micro-second: 0 - 65535)</p>	
Return Values	RS_SUCCESS	Function call succeeded.
	Error code (refer. 4-5)	Function call failed.

Definition	VC	RS_STATUS usb61_i2c_pullup(HANDLE hUsb61Device, RS_I2C_PULLUP fI2cPullup);
	VB	Function Usb61I2cPullup(ByVal hUsb61Device As Long, ByVal fI2cPullup As Integer) As Long
	VB.NET	Function Usb61I2cPullup(ByVal hUsb61Device As Integer, ByVal fI2cPullup As Short) As Integer
Description	Set pullup on I2C bus. (Each pin of SDA and SCL)	
Parameters	<p>[IN] hUsb61Device : handle of an REX-USB61 device</p> <p>[IN] fI2cPullup : pullup setting</p> <p>Set the value by using the defined symbol as the following:</p> <p>RS_I2C_PULLUP_DISABLE Not set pull-up the pin SCL and SDA. RS_I2C_PULLUP_ENABLE Set pull-up the pin of SCL and SDA.</p> <p>* When I2C, SPI mode, always set ENABLE.(Can select only 1MHz I2C mode)</p>	
Return Values	RS_SUCCESS	Function call succeeded.
	Error code (refer. 4-5)	Function call failed.

GPO (Only on I2C mode)

Definition	VC	RS_STATUS usb61_gpo_write(HANDLE hUsb61Device, UINT fPortVal);
	VB	Function Usb61GpoWrite(ByVal hUsb61Device As Long, ByVal fPortVal As Long) As Long
	VB.NET	Function Usb61GpoWrite(ByVal hUsb61Device As Integer, ByVal fPortVal As Integer) As Integer
Description	Output to the GPO pin on I2C mode.	
Parameters	<p>[IN] hUsb61Device : handle of an REX-USB61 device</p> <p>[IN] fPortVal : a bitmask specifying which outputs to GPO pin.</p> <p>GPO line location of bit mask by using the defined symbol as the following:</p> <p>RS_GPO_NONE Set Low(=0) to all port RS_GPO_PORT0 Set High(=1) to PORT0 RS_GPO_PORT1 Set High(=1) to PORT1 RS_GPO_PORT2 Set High(=1) to PORT2 RS_GPO_PORT3 Set High(=1) to PORT3</p> <p>For setting to multiple GPO port at the same time, bit operation as the following:</p> <p>example:</p> <p>RS_GPO_PORT0 RS_GPO_PORT1 output PORT1 and PORT2</p>	
Return Values	RS_SUCCESS	Function call succeeded.
	Error code (refer. 4-5)	Function call failed.

General on I2C mode

Definition	VC	RS_STATUS <code>usb61_i2c_bus_reset(HANDLE hUsb61Device);</code>
	VB	Function <code>Usb61I2cBusReset(ByVal hUsb61Device As Long) As Long</code>
	VB.NET	Function <code>Usb61I2cBusReset(ByVal hUsb61Device As Integer) As Integer</code>
Description	Reset I2C bus. Set the Stop condition to the I2C bus	
Parameters	[IN] <code>hUsb61Device</code> : handle of an REX-USB61 device	
Return Values	<code>RS_SUCCESS</code>	Function call succeeded.
	Error code (refer. 4-5)	Function call failed.

Definition	VC	RS_STATUS <code>usb61_i2c_set_freq(HANDLE hUsb61Device, RS_I2C_FREQ fI2cFreq);</code>
	VB	Function <code>Usb61I2cSetFreq(ByVal hUsb61Device As Long, ByVal fI2cFreq As Integer) As Long</code>
	VB.NET	Function <code>Usb61I2cSetFreq(ByVal hUsb61Device As Integer, ByVal fI2cFreq As Short) As Integer</code>
Description	Configures I2C bus frequency	
Parameters	[IN] <code>hUsb61Device</code> : handle of an REX-USB61 device [IN] <code>fI2cFreq</code> :the frequency of I2C bus enumerated type of frequency by using the defined symbol as the following: <code>RS_I2C_FREQ_1M</code> 1MHz <code>RS_I2C_FREQ_400K</code> 400KHz <code>RS_I2C_FREQ_100K</code> 100KHz	
Return Values	<code>RS_SUCCESS</code>	Function call succeeded.
	Error code (refer. 4-5)	Function call failed.

Definition	VC	RS_STATUS <code>usb61_i2c_set_freq_ex(HANDLE hUsb61Device, USHORT Frequency, USHORT *pActualFrequency);</code>
	VB	Function <code>Usb61I2cSetFreqEx(ByVal hUsb61Device As Long, ByVal Frequency As Long, pActualFrequency As Long) As Long</code>
	VB.NET	Function <code>Usb61I2cSetFreqEx(ByVal hUsb61Device As Integer, ByVal Frequency As Integer, ByRef pActualFrequency As Integer) As Integer</code>
Description	Configures the I2C bus frequency in kilohertz. Can be set from 47 to 100KHz. The actual frequency value to be set return to the pActualFrequency.	
Parameters	[IN] <code>hUsb61Device</code> : Handle of an REX-USB61 device [IN] <code>Frequency</code> : The frequency to request on I2C bus [OUT] <code>pActualFrequency</code> : The actual frequency value to be set	
Return Values	<code>RS_SUCCESS</code>	Function call succeeded.
	Error code (refer. 4-5)	Function call failed.

I2C bus operation on I2C bus master mode

Definition	VC	RS_STATUS usb61_i2c_read_master(HANDLE hUsb61Device, USHORT SlaveAddress, UINT fI2cOption, USHORT ReadBytes, UCHAR *pReadBuf);
	VB	Function Usb61I2cReadMaster(ByVal hUsb61Device As Long, ByVal SlaveAddress As Integer, ByVal fI2cOption As Long, ByVal ReadBytes As Integer, pReadBuf As Byte) As Long
	VB.NET	Function Usb61I2cReadMaster(ByVal hUsb61Device As Integer, ByVal slaveAddress As Short, ByVal fI2cOption As Integer, ByVal readBytes As Short, ByRef pReadBuf As Object) As Integer
Description	Read a stream of bytes from the I2C slave device.	
Parameters	[IN] hUsb61Device : handle of an REX-USB61 device [IN] SlaveAddress : the slave from which to read. See the below [IN] fI2cOption : special operation as described in "Table 4-2" and below [IN] ReadBytes : the number of bytes to read [OUT] pReadBuf : pointer to data to read.	
Return Values	RS_SUCCESS	Function call succeeded.
	Error code (refer. 4-5)	Function call failed.

***Slave address:**

Specify the slave address in 7bits or 10bits, not includes R/W bit.

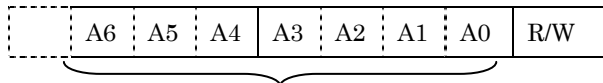

Slave address

[Examples : slave address = 52h]

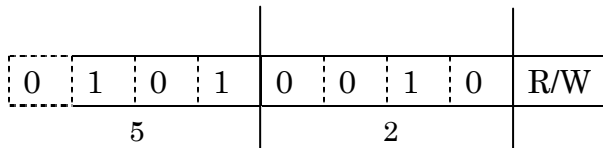

Definition	VC	RS_STATUS usb61_i2c_read_master_ex(HANDLE hUsb61Device, USHORT SlaveAddress, USHORT SubAddress, UINT fI2cOption, USHORT ReadBytes, UCHAR *pReadBuf);
	VB	Function Usb61I2cReadMasterEx(ByVal hUsb61Device As Long, ByVal SlaveAddress As Integer, ByVal SubAddress As Integer, ByVal fI2cOption As Long, ByVal ReadBytes As Integer, pReadBuf As Byte) As Long
	VB.NET	Function Usb61I2cReadMasterEx(ByVal hUsb61Device As Integer, ByVal slaveAddress As Short, ByVal subAddress As Short, ByVal fI2cOption As Integer, ByVal readBytes As Short, ByRef pReadBuf As Object) As Integer
Description	Read a stream of bytes from the I2C slave device with sub-address. It is different from the "usb61_i2c_read_master" function that write data before for reading with the specifying the calling position (specifying sub-address) on inside function.	
Parameters	[IN] hUsb61Device : handle of an REX-USB61 device [IN] SlaveAddress : the slave from which to read. See *Slave address in Page4-16. [IN] SubAddress : Sub address (supports 2 bytes-address) [IN] fI2cOption : special operation as described in "Table 4-2" and below [IN] ReadBytes : the number of bytes to read [OUT] pReadBuf : pointer to data to read.	
Return Values	RS_SUCCESS Error code (refer. 4-5)	Function call succeeded. Function call failed.

Definition	VC	RS_STATUS usb61_i2c_write_master(HANDLE hUsb61Device, USHORT SlaveAddress, UINT fI2cOption, USHORT WriteBytes, UCHAR *pWriteBuf);
	VB	Function Usb61I2cWriteMaster(ByVal hUsb61Device As Long, ByVal SlaveAddress As Integer, ByVal fI2cOption As Long, ByVal WriteBytes As Integer, ByVal pWriteBuf As Byte) As Long
	VB.NET	Function Usb61I2cWriteMaster(ByVal hUsb61Device As Integer, ByVal slaveAddress As Short, ByVal fI2cOption As Integer, ByVal writeBytes As Short, ByVal pWriteBuf As Object) As Integer
Description	Write a stream of bytes to the I2C slave device	
Parameters	<p>[IN] hUsb61Device : handle of an REX-USB61 device</p> <p>[IN] SlaveAddress : the slave from which to read. See *Slave address in Page4-16.</p> <p>[IN] fI2cOption : special operation as described in "Table 4-2" and below</p> <p>[IN] WriteBytes : the number of bytes to write</p> <p>[IN] pWriteBuf : pointer to data to write</p>	
Return Values	RS_SUCCESS	Function call succeeded.
	Error code (refer. 4-5)	Function call failed.

Table 4-2. Special operation on I2C bus

Literal Name	Value	Description
RS_I2C_FLAG_NONE	0x00	No flags.
RS_I2C_FLAG_10BIT_ADDR	0x01	For 10-bits address device
RS_I2C_FLAG_STOP	0x02	Set before issue the stop condition
RS_I2C_FLAG_1BYTE_SA	0x04	Send 1 byte sub-address before reading data
RS_I2C_FLAG_2BYTE_SA	0x0C	Send 2 bytes sub-address before reading data

I2C bus operation on I2C bus slave mode

Definition	VC	RS_STATUS usb61_i2c_read_slave(HANDLE hUsb61Device, RS_NOTIFY_TYPE nType, void (CALLBACK EXPORT* lpfnReadEvent) (USHORT ReadBytes, UCHAR *pReadBuf), HWND hWnd);
	VB	Function Usb61I2cReadSlave(ByVal hUsb61Device As Long, ByVal nType As Integer) As Long
	VB.NET	Function Usb61I2cReadSlave(ByVal hUsb61Device As Integer, ByVal nType As Short) As Integer
Description	<p>Read a stream of bytes from the I2C master device.</p> <p>In background, waiting until it receives the data from master device, after call this function.</p> <p>The completion of receiving the data, it is notified to the application via callback function.</p> <p>Before calling this function, have to call the “usb61_i2c_set_response_data()” function to set the data for sending to master device in advance.</p> <p>On Visual Basic, by using ActiveX control, as user-defined-message "WM_USB61_MSG" is notified.</p>	
Parameters	<p>[IN] hUsb61Device : handle of an REX-USB61 device</p> <p>[IN] nType : notification method</p> <p>enumerated type of notification method by using the defined symbol as the following:</p> <p style="padding-left: 40px;">RS_NOTIFY_CALLBACK notified by callback function (only VC)</p> <p style="padding-left: 40px;">RS_NOTIFY_USER_MSG notified by user message</p> <p>[IN] lpfnReadEvent : callback function which notify to application</p> <p>'lpfnReadEvent' callback function supplied by the upper application is set as the argument.</p> <p>The name of 'lpfnReadEvent' callback function does not have to be 'ReadIsComplete', but it must be defined as follows:</p> <p style="padding-left: 40px;">void CALLBACK EXPORT ReadIsComplete(USHORT ReadBytes, UCHAR *pReadBuf);</p> <p>[IN] hWnd : window handle which notify user message if not notify user message, set NULL</p>	
Return Values	RS_SUCCESS Error code (refer. 4-5)	Function call succeeded. Function call failed.

Definition	VC	No use on VC
	VB	Function Usb61GetData(ByVal wParam As Long, ByVal lParam As Long, ByVal pBuf As Byte) As Long
	VB.NET	Function Usb61GetData(ByVal wParam As Integer, ByVal lParam As Integer, ByVal pBuf As Object) As Integer
Description	Get the data by using the "Usb61I2cReadSlave" function, when the "WM_USB61_MSG" message is posted	
Parameters	<p>[IN] wParam : the number of bytes to read</p> <p>[IN] lParam : address of the data to read</p> <p>[OUT] pBuf : pointer to the data to read</p> <p><i>Example on VB:</i></p> <pre>Private Sub Usb61api_OnEventMsg(ByVal wParam As Long, ByVal lParam As Long) ' Status code Dim rsStatus As Long Dim pBuf() As Byte ReDim pBuf(wParam) As Integer rsStatus = Usb61api.Usb61GetData(wParam, lParam, pBuf) End Sub</pre>	
Return Values	RS_SUCCESS	Function call always succeeded.

Definition	VC	RS_STATUS usb61_i2c_set_response_data(HANDLE hUsb61Device, USHORT ResponseBytes, UCHAR *pResponseBuf);
	VB	Function Usb61I2cSetResponseData(ByVal hUsb61Device As Long, ByVal ResponseBytes As Integer, ByVal pResponseBuf As Byte) As Long
	VB.NET	Function Usb61I2cSetResponseData(ByVal hUsb61Device As Integer, ByVal responseBytes As Short, ByVal pResponseBuf As Object) As Integer
Description	Set the data for sending to master device on I2C slave mode When receive data from master device, send the data pre-set for master	
Parameters	<p>[IN] hUsb61Device : handle of an REX-USB61 device</p> <p>[IN] ResponseBytes : the number of bytes for sending to master device</p> <p>[IN] pResponseBuf : pointer to the data for sending to master device</p>	
Return Values	RS_SUCCESS	Function call succeeded.
	Error code (refer. 4-5)	Function call failed.

SPI bus operation on SPI bus master mode

Definition	VC	RS_STATUS <code>usb61_spi_set_freq(HANDLE hUsb61Device, UINT fDataMode, USHORT Frequency, USHORT *pActualFrequency);</code>
	VB	Function <code>Usb61SpiSetFreq(ByVal hUsb61Device As Long, ByVal fDataMode As Long, ByVal Frequency As Long, pActualFrequency As Long) As Long</code>
	VB.NET	Function <code>Usb61SpiSetFreq(ByVal hUsb61Device As Integer, ByVal fDataMode As Integer, ByVal frequency As Integer, ByRef pActualFrequency As Integer) As Integer</code>
Description	<p>Set the SPI bus frequency in kilohertz.</p> <p>Can be set from 1 to 12000KHz.</p> <p>The approximate value of frequency that can be set is calculated from the 'Frequency' parameter.</p> <p>The actual frequency value to be set, returns to the 'pActualFrequency' parameter.</p> <p>Note: The approximate value of frequency will be calculated as the follows:</p> <p>The X is the integer part of the value that 6024 divided by the 'Frequency' parameter.</p> <p>If the X is greater than or equal to 1020, [X >= 1020] Y = integer of (X / 16) *pActualFrequency = integer of 6024 / (Y * 16)</p> <p>The Y is the integer part of the value that X divided by 16. The integer part of the value which 6024 divided by 16 multiple of Y, will set to the 'pActualFrequency' parameter.</p> <p>If the X is greater than or equal to 256 and smaller than 1020 [256 <= X < 1020] Y = integer of (X / 4) *pActualFrequency = integer of 6024 / (Y * 4)</p> <p>The Y is the integer part of the value that X divided by 4. The integer part of the value which 6024 divided by 4 multiple of Y, will set to the 'pActualFrequency' parameter.</p> <p>If the X is smaller than 256 [X < 256] *pActualFrequency = integer of 6024 / X</p> <p>The integer part of the value which 6024 divided by X, will set to the 'pActualFrequency' parameter.</p> <p>When the 'Frequency' parameter is 1, 750, 300, 12000(KHz), these frequency has special setting value. Therefore, the same value as the Frequency is returned to the 'pActualFrequency' parameter.</p> <p>When the 'Frequency' parameter is greater than or equal to 3013(KHz), 12000(KHz) will set to the 'pActualFrequency' parameter.</p>	

Parameters	<p>[IN] hUsb61Device : handle of an REX-USB61 device</p> <p>[IN] fDataMode : a bit mask specifying which operation mode for sending on SPI bus.</p> <p>The clock polarity and the clock edge determine the value of bit mask.</p> <p>The bit mask by using the defined symbol as the following:</p> <table> <tr> <td>RS_SPI_PHASE_SETUP_SAMPLE</td> <td>sampling on rising edge</td> </tr> <tr> <td>RS_SPI_PHASE_SAMPLE_SETUP</td> <td>sampling on falling edge</td> </tr> <tr> <td>RS_SPI_POLARITY_POSITIVE</td> <td>clock polarity is positive</td> </tr> <tr> <td>RS_SPI_POLARITY_NEGATIVE</td> <td>clock polarity is negative</td> </tr> <tr> <td>RS_SPI_MSB_FIRST</td> <td>MBS first</td> </tr> <tr> <td>RS_SPI_LSB_FIRST</td> <td>LSB first</td> </tr> </table> <p><i>example:</i></p> <p>RS_SPI_PHASE_SETUP_SAMPLE RS_SPI_POLARITY_POSITIVE RS_SPI_MSB_FIRST</p> <p>[IN] Frequency : the frequency to request on SPI bus</p> <p>[OUT] pActualFrequency: the actual frequency value to be set</p>	RS_SPI_PHASE_SETUP_SAMPLE	sampling on rising edge	RS_SPI_PHASE_SAMPLE_SETUP	sampling on falling edge	RS_SPI_POLARITY_POSITIVE	clock polarity is positive	RS_SPI_POLARITY_NEGATIVE	clock polarity is negative	RS_SPI_MSB_FIRST	MBS first	RS_SPI_LSB_FIRST	LSB first
RS_SPI_PHASE_SETUP_SAMPLE	sampling on rising edge												
RS_SPI_PHASE_SAMPLE_SETUP	sampling on falling edge												
RS_SPI_POLARITY_POSITIVE	clock polarity is positive												
RS_SPI_POLARITY_NEGATIVE	clock polarity is negative												
RS_SPI_MSB_FIRST	MBS first												
RS_SPI_LSB_FIRST	LSB first												
Return Values	<table> <tr> <td>RS_SUCCESS</td> <td>Function call succeeded.</td> </tr> <tr> <td>Error code (refer. 4-5)</td> <td>Function call failed.</td> </tr> </table>	RS_SUCCESS	Function call succeeded.	Error code (refer. 4-5)	Function call failed.								
RS_SUCCESS	Function call succeeded.												
Error code (refer. 4-5)	Function call failed.												

Definition	VC	RS_STATUS usb61_spi_transmit_master(HANDLE hUsb61Device, RS_SPI_SS fSlaveSelect, USHORT TransmitSize, UCHAR *pSendBuf, UCHAR *pRecvBuf);								
	VB	Function Usb61SpiTransmitMaster(ByVal hUsb61Device As Long, ByVal fSlaveSelect As Integer, ByVal TransmitSize As Integer, ByVal pSendBuf As Byte, pRecvBuf As Byte) As Long								
	VB.NET	Function Usb61SpiTransmitMaster(ByVal hUsb61Device As Integer, ByVal fSlaveSelect As Short, ByVal transmitSize As Short, ByVal pSendBuf As Object, ByRef pRecvBuf As Object) As Integer								
Description	<p>Write a stream of bytes to the downstream SPI slave device and read back dummy data.</p> <p>After write, set SS line status to High.</p>									
Parameters	<p>[IN] hUsb61Device : handle of an REX-USB61 device</p> <p>[IN] fSlaveSelect : Pin number for slave select</p> <p>enumerated values specifying pin number the bellow:</p> <table> <tr> <td>RS_SPI_SS0</td> <td>Slave select pin number 0</td> </tr> <tr> <td>RS_SPI_SS1</td> <td>Slave select pin number 1</td> </tr> <tr> <td>RS_SPI_SS2</td> <td>Slave select pin number 2</td> </tr> <tr> <td>RS_SPI_SS3</td> <td>Slave select pin number 3</td> </tr> </table> <p>[IN] TransmitSize : the number of bytes to write</p> <p>[IN] pSendBuf : pointer to write data</p> <p>[OUT] pRecvBuf : pointer to read back data</p>		RS_SPI_SS0	Slave select pin number 0	RS_SPI_SS1	Slave select pin number 1	RS_SPI_SS2	Slave select pin number 2	RS_SPI_SS3	Slave select pin number 3
RS_SPI_SS0	Slave select pin number 0									
RS_SPI_SS1	Slave select pin number 1									
RS_SPI_SS2	Slave select pin number 2									
RS_SPI_SS3	Slave select pin number 3									
Return Values	<table> <tr> <td>RS_SUCCESS</td> <td>Function call succeeded.</td> </tr> <tr> <td>Error code (refer. 4-5)</td> <td>Function call failed.</td> </tr> </table>		RS_SUCCESS	Function call succeeded.	Error code (refer. 4-5)	Function call failed.				
RS_SUCCESS	Function call succeeded.									
Error code (refer. 4-5)	Function call failed.									

Definition	VC	RS_STATUS usb61_spi_transmit_master_hold_ss(HANDLE hUsb61Device, RS_SPI_SS fSlaveSelect, USHORT TransmitSize, UCHAR *pSendBuf, UCHAR *pRecvBuf);
	VB	Function Usb61SpiTransmitMasterHoldSS(ByVal hUsb61Device As Long, ByVal fSlaveSelect As Integer, ByVal TransmitSize As Integer, ByVal pSendBuf As Byte, pRecvBuf As Byte) As Long
	VB.NET	Function Usb61SpiTransmitMasterHoldSS(ByVal hUsb61Device As Integer, ByVal fSlaveSelect As Short, ByVal transmitSize As Short, ByVal pSendBuf As Object, ByRef pRecvBuf As Object) As Integer
Description	Write a stream of bytes to the downstream SPI slave device and read back dummy data. After write, not set SS line status to High. For setting SS line to High, call usb61_gpo_write function.	
Parameters	<p>[IN] hUsb61Device : handle of an REX-USB61 device</p> <p>[IN] fSlaveSelect : Pin number for slave select</p> <p>enumerated values specifying pin number the bellow:</p> <p>RS_SPI_SS0 Slave select pin number 0</p> <p>RS_SPI_SS1 Slave select pin number 1</p> <p>RS_SPI_SS2 Slave select pin number 2</p> <p>RS_SPI_SS3 Slave select pin number 3</p> <p>[IN] TransmitSize : the number of bytes to write</p> <p>[IN] pSendBuf : pointer to write data</p> <p>[OUT] pRecvBuf : pointer to read back data</p>	
Return Values	RS_SUCCESS	Function call succeeded.
	Error code (refer. 4-5)	Function call failed.

(4-5) Error Codes

Table 4-3. API Error Codes

Literal Name	Value	Description
RS_SUCCESS	0	Function call succeeded
RS_OK	0	ok
RS_DEVICE_FOUND	0	device is found
RS_DEVICE_CONNECT	0	device is connected
RS_UNABLE_TO_LOAD_LIBRARY	-1	unable to load library
RS_UNABLE_TO_LOAD_DRIVER	-2	unable to load REX-USB61 driver
RS_UNABLE_TO_LOAD_FUNCTION	-3	unable to call function
RS_INCOMPATIBLE_LIBRARY	-4	incompatible library version
RS_INCOMPATIBLE_DEVICE	-5	incompatible device
RS_COMMUNICATION_ERROR	-6	communication error
RS_UNABLE_TO_OPEN	-7	unable to open device
RS_UNABLE_TO_CLOSE	-8	unable to close device
RS_INVALID_HANDLE	-9	invalid device handle
RS_CONFIG_ERROR	-10	configuration error
RS_TIMEOUT	-11	time out
RS_OUT_OF_RANGE	-12	out of range
RS_DEVICE_NOT_FOUND	-20	device not found
RS_DEVICE_NOT_CONNECT	-21	device not connected
RS_DEVICE_OPEN_EXIST	-22	device already opened
RS_I2C_NOT_AVAILABLE	-100	I2C bus not available
RS_I2C_NOT_ENABLED	-101	I2C not enabled
RS_I2C_READ_ERROR	-102	I2C read error
RS_I2C_WRITE_ERROR	-103	I2C wrtie error
RS_I2C_BAD_CONFIG	-104	I2C bad configuration
RS_I2C_TIMEOUT	-105	I2C bus timeout
RS_I2C_DROPPED_EXCESS_BYTES	-106	I2C dropped excess bytes
RS_I2C_BUS_ALREADY_FREE	-107	I2C bus already free
RS_I2C_WRITE_COLLISION	-108	I2C write collision
RS_I2C_READ_OVERFLOW	-109	I2C read overflow
RS_I2C_NACK_DETECT	-110	I2C no ack detected
RS_I2C_OUTRANGE	-111	I2C out of range
RS_SPI_NOT_AVAILBLE	-200	SPI bus not available
RS_SPI_NOT_ENABLED	-201	SPI bus not enabled
RS_SPI_WRITE_ERROR	-202	SPI write error
RS_SPI_READ_ERROR	-203	SPI read error
RS_SPI_BAD_CONFIG	-204	SPI bad configuration
RS_SPI_TIMEOUT	-205	SPI bus timeout
RS_SPI_DROPPED_EXCESS_BYTES	-206	SPI dropped excess bytes
RS_SPI_WRITE_OVERFLOW	-207	SPI write overflow
RS_SPI_OUTRANGE	-208	SPI out of range
RS_GPO_NOT_AVAILABLE	-300	GPO port not available
RS_FAILURE	-400	general error

* A positive value of except above is error code of Win32.

(4-6) Sample Applications

REX-USB61 includes a sample application of reference of the application development.

The "EEPROM R / W Utility" sample application that can read and write for the EEPROM (ATMEL AT24C02B, AT25080A) with I2C interface or SPI. It includes in the "EEPROMRWUty" folder.

The "I2cSlaveSample" sample application can work as I2C slave for the REX-USB61.

It includes in the "I2CSlaveSample" folder.

[Description of EEPROM R/W Utility]

Select SPI/I2C Bus select mode SPI or I2C
Direction Read or Write
Operation Frequency Enter the frequency for setting
Actual Frequency Display the frequency that calculated from the above value.
Interval Configure Interval of 1 byte for sending
I2C Target address Enter I2C target address
EEPROM Address Start position for reading or writing
Transfer length Transfer length for reading or writing
Write Data Transfer data for writing
Read Data Display received data
Execute Start transfer by the above settings

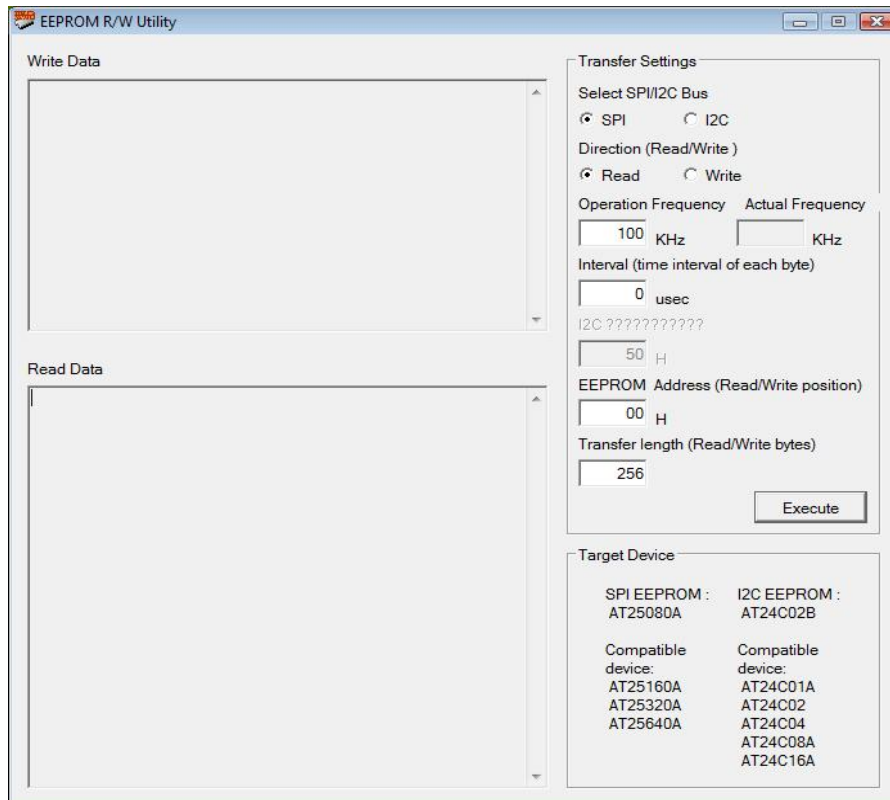

[View of EEPROM R/W Utility]

See the source code for programming.

And refer to the specification of the EEPROM which the EEPROM maker provides.

[Description of I2CSlaveSample]

- I2C Slave address Set I2C slave address
- Operation Frequency of I2C Master
.... Select frequency of I2C master device
- Response data Set response data for I2C master
- Execute Start for I2C slave
- Receive data Display receive data from I2C master
- Clear Erase displayed receive data

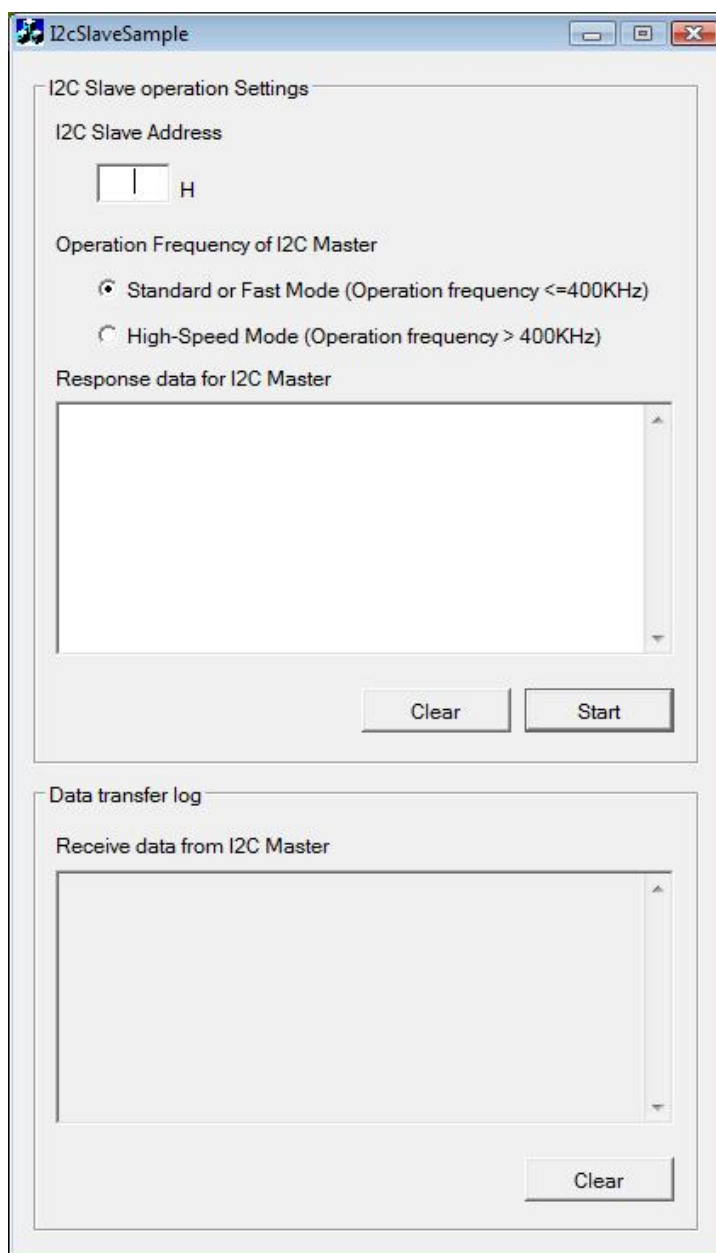

[View of I2CSlaveSample]

See the source code for programming.

(4-7) How to develop application using this API functions

This section describes how to create a control application using the REX-USB61 API functions.

It is an example in C++. If you want to know in other programming language or detail, refer to the source code of the sample programs.

Example - EEPROM R/W Utility [I2C] :

Output a byte 'FF' hex-decimal data from SDA line. (C++)

It does not include error handling.

```

HANDLE hDeviceHandle;    // Device handle
BYTE DeviceAddr;        // Device address
WORD DataLen;           // Transfer length
USHORT i2cFreq;         // Operating frequency
WORD ActualFreq;        // Actual frequency
USHORT IntervalCnt;     // Interval
BYTE Data;              // Data for writing

// Get device handle
hDeviceHandle = usb61_open(&rsStatus);

// Supply 5.0V power to target device.
// Using the source power from target device without from REX-USB61,
// Set RS_PWRCTRL_OFF
usb61_power_control(hDeviceHandle, RS_PWRCTRL_ON | RS_OUTPUT_5_0V);

// Set I2C master mode
usb61_mode_change(hDeviceHandle, RS_DEVMODE_I2C | RS_DEVMODE_MASTER, NULL);

// Set Interval (After I2C mode changed)
usb61_set_interval(hDeviceHandle, IntervalCnt);

// Set I2C bus pull-up
usb61_i2c_pullup( hDeviceHandle, RS_I2C_PULLUP_ENABLE );

// Set frequency
usb61_i2c_set_freq_ex( hDeviceHandle, i2cFreq, &ActualFreq );

// Output a byte 'FF' hex-decimal data from SDA line
// Set target device address to the "DeviceAddr". Do not include R/W bit,
// Set x00 to Device address.
DeviceAddr = 0x00;    // Device address = 0x00
Data       = 0xFF;    // A byte 'FF' hex-decimal data
DataLen    = 1;      // length of data = 1
usb61_i2c_write_master( hDeviceHandle, DeviceAddr, RS_I2C_FLAG_STOP, DataLen, &Data );

// Finish using the REX-USB61 device
usb61_close(hDeviceHandle);
hDeviceHandle = NULL;

```

Example - EEPROM R/W Utility [SPI] :

Output a byte 'FF' hex-decimal data from SDO line. (C++)

It does not include error handling.

```

HANDLE hDeviceHandle;    // Device handle
WORD DataLen;           // Transfer length
USHORT spiFreq;         // Operating frequency
WORD ActualFreq;        // Actual frequency
BYTE pWriteBuf;         // Store data for writing
BYTE pReadBuf;          // Store data for reading
UINT uiFlag;            // bit combination of clock leading or trailing, polarity

// Get device handle
hDeviceHandle = usb61_open(&rsStatus);

// Supply 5.0V power to target device.
// Using the source power from target device without from REX-USB61,
// Set RS_PWRCTRL_OFF
usb61_power_control(hDeviceHandle, RS_PWRCTRL_ON | RS_OUTPUT_5_0V);

// Set SPI master mode
usb61_mode_change(hDeviceHandle, RS_DEVMODE_SPI | RS_DEVMODE_MASTER, NULL);

// Set Interval (After SPI mode changed)
usb61_set_interval(hDeviceHandle, IntervalCnt);

// Set frequency
uiFlag = RS_SPI_PHASE_SAMPLE_SETUP | RS_SPI_POLARITY_POSITIVE
         | RS_SPI_MSB_FIRST;
usb61_spi_set_freq(hDeviceHandle, uiFlag, spiFreq, &ActualFreq);

// Send the Write Enable command(0x06)
pWriteBuf[0] = 0x06; // WREN command
DataLen = 1          // Transfer length
usb61_spi_transmit_master(hDeviceHandle, RS_SPI_SS0, DataLen, pWriteBuf, pReadBuf);

// Output a byte 'FF' hex-decimal data from SDO line
// Send [Write command(0x02) + EEPROM address(0x0000) + data for writing(0xff)] 4bytes
pWriteBuf[0] = 0x02 // Write command
pWriteBuf[1] = 0x00 // EEPROM address(upper byte)
pWriteBuf[2] = 0x00 // EEPROM address(lower byte)
pWriteBuf[3] = 0xff // Data for writing
DataLen = 4          // Transfer length
usb61_spi_transmit_master(hDeviceHandle, RS_SPI_SS0, DataLen, pWriteBuf, pReadBuf);
// In reading, after the fourth of byte are data.

// Finish using the REX-USB61 device
usb61_close(hDeviceHandle);
hDeviceHandle = NULL;

```

Example – I2cSlaveSample [I2C] :

This program operates as a slave device for REX-USB61.

When reading from the I2C master device, send the response data which prepared in advance to the I2C master device.

The transmission of data from the I2C master device is notified by the event of receipt or the callback function.

And it is displayed on the application program. (C++)

It does not include error handling.

```

HANDLE hDeviceHandle;    // Device handle
char    csSlaveAddr[16]; // Character string for I2C slave address
ULONG   ulSlaveAddr;     // I2C slave address
char    *stopstring;
USHORT  usFreq;          // Operating frequency
USHORT  usActualFreq;    // Actual frequency
BYTE    ResponseBuf[255]; // response data
WORD    ResponseBytes;   // length of response data

// Get device handle
hDeviceHandle = usb61_open(&rsStatus);

// Supplies a power supply from I2C master
// REX-USB61 does not supply power
usb61_power_control(hDeviceHandle, RS_PWRCTRL_OFF);

// I2C slave address
GetDlgItemText(hwnd, IDE_SLAVE_ADDRESS, csSlaveAddr, sizeof(csSlaveAddr));
ulSlaveAddr = strtoul(csSlaveAddr, &stopstring, 16);

// Set I2C slave mode
usb61_mode_change(hDeviceHandle, RS_DEVMODE_I2C | RS_DEVMODE_SLAVE,
                  (USHORT)ulSlaveAddr);

// Enable pull-up
usb61_i2c_pullup(hDeviceHandle, (RS_I2C_PULLUP)fPullup );

// Set frequency
usb61_i2c_set_freq_ex(hDeviceHandle, usFreq, &usActualFreq);

// Set response data
// usb61_i2c_set_response_data(hDeviceHandle, ResponseBytes, ResponseBuf);

// Waiting for receiving data as I2C slave
// Save device handle
g_hwnd = hwnd;
// By using user-message, be notified the event of receipt
usb61_i2c_read_slave(hDeviceHandle, RS_NOTIFY_USER_MSG, NULL, g_hwnd );

:

```

(When notified by event of receipt, receive user-message and display the transmission of data from the I2C master device.)

